

## PROFESSIONAL AMPLIFIER SERIES | 2 RU

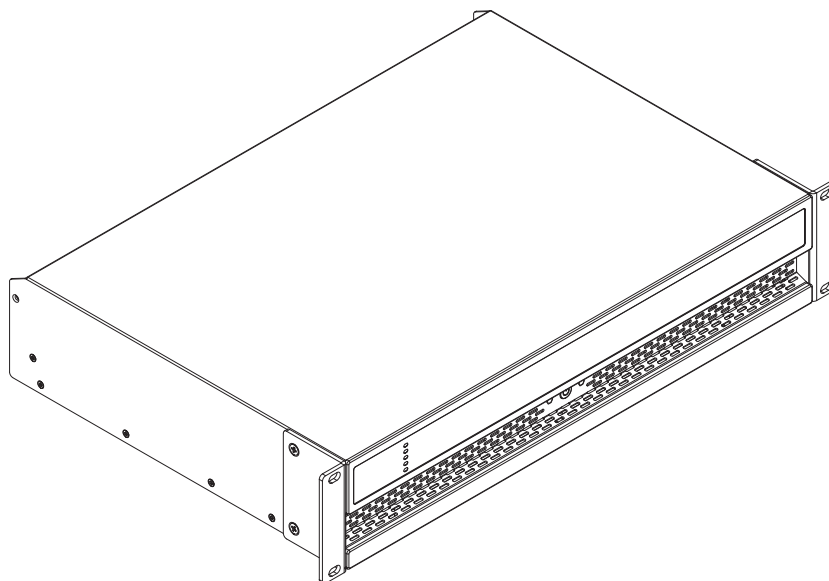

### INSTALLATION MANUAL

ProA1000.1 • ProA1000.1D • ProA1000.2 • ProA1000.2D

ProA1200.1 • ProA1200.1D • ProA1200.2 • ProA1200.2D

*Please visit [www.originpro.com](http://www.originpro.com) or scan the QR code using your smart device for the most up to date safety information and use instructions for this product.*



Please read the following important technical, safety and environmental notices before installing and using your amplifier.

## Technical & Safety Notices

All reasonable design and engineering steps have been taken to ensure that these amplifiers always perform satisfactorily in their intended application and environment and will provide appropriate levels of support to ensure that all reasonable customer needs and expectations are met. Such support however is contingent on the following provisions.

1. These amplifiers are Class-I products and should be installed with a mains cable including the required earth connection to comply with the Safety Class-I.
2. These amplifiers should always be installed by competent and qualified personnel. Amplifier damage or failure caused by installation or operational errors may invalidate support, warranty or guarantees of performance.
3. These amplifiers are not suitable for use in locations where they may be accessible to minors.
4. These amplifiers are intended to be used specifically for the amplification of audio signals and for connection to moving-coil loudspeaker systems. Use of these amplifiers for amplification of signals outside the audio band (20Hz to 20kHz) or to drive transducers other than moving-coil loudspeakers may invalidate support, warranty or guarantees of performance.
5. These amplifiers should only be used within professionally installed and configured audio systems comprising input and output ancillary equipments that is known to be of an appropriate level of performance and in good operating condition. Any damage to, or unsatisfactory performance from, these amplifiers caused by inadequate or failed input or output ancillaries may invalidate support, warranty or guarantees of performance.
6. These amplifiers are intended to be installed and operated indoor in a controlled environment (pollution degree, PD2) within an ambient temperature range of 0°C to 40°C.  
These amplifiers are not intended for use above 2000 meters above sea level. Amplifiers installed or operated in environments outside these limits may invalidate support, warranty or guarantees of performance.
7. Specific warranty terms are the responsibility of the amplifier re-seller.

## Safety and Environmental Notices

*Note: The intent of the lightning flash with arrowhead symbol in a triangle is to alert the user to the presence of uninsulated “dangerous” voltage within the product’s enclosure that may be of sufficient magnitude to constitute a risk of electric shock to humans.*

*Note: The intent of the exclamation point within an equilateral triangle is to alert the user to the presence of important safety, and operating and maintenance instructions in this manual.*

**WARNING! TO PREVENT FIRE OR ELECTRIC SHOCK, DO NOT EXPOSE THIS EQUIPMENT TO RAIN OR MOISTURE.**



**Ambient Temperature Note: If this equipment is operated in a confined or multiple rack installation, the internal ambient operating temperature may exceed the external ambient temperature. It is important to ensure in these circumstances that the published maximum operating temperature for the equipment is not exceeded.**



**Reduced Air Flow: Ensure that rack or other closed installation does not restrict the cooling airflow required for safe and reliable operation of the equipment.**

## Important Safety Instructions

1. Read these instructions.
2. Keep these instructions.
3. Heed all warnings.
4. Follow all instructions.
5. Do not use this apparatus near water.
6. Do not submerge the equipment in water or liquids.
7. Do not use any aerosol spray, cleaner, disinfectant or fumigant on, near or into the equipment.
8. Clean only with a dry cloth.
9. Do not block any ventilation opening. Install in accordance with the manufacturer's instructions.
10. Do not install near any heat sources such as radiators, heat registers, stoves, or other apparatus (including amplifiers) that produce heat.
11. To reduce the risk of electrical shock, the power cord shall be connected to a mains socket outlet with a protective earthing connection.
12. Do not defeat the safety purpose of the polarized or grounding type plug. A polarized plug has two blades with one wider than the other. A grounding type plug has two blades and a third grounding prong. The wide blade or the third prong are provided for your safety. If the provided plug does not fit into your outlet, consult an electrician for replacement of the obsolete outlet.
13. Protect the power cord from being walked on or pinched particularly at plugs, convenience receptacles, and the point where they exit from the apparatus.
14. Do not unplug the unit by pulling on the cord, use the plug.
15. Only use attachments/accessories specified by the manufacturer.
16. Unplug this apparatus during lightning storms or when unused for long periods of time.
17. Refer all servicing to qualified service personnel. Servicing is required when the apparatus has been damaged in any way, such as power supply cord or plug is damaged, liquid has been spilled or objects have fallen into the apparatus, the apparatus has been exposed to rain or moisture, does not operate normally, or has been dropped.
18. The appliance coupler, or the AC Mains plug, is the AC mains disconnect device and shall remain readily accessible after installation.
19. Adhere to all applicable, local codes.
20. Consult a licensed, professional engineer when any doubt or questions arise regarding a physical equipment installation.

## Environmental Statement

This product complies with international directives, including but not limited to the Restriction of Hazardous Substances (RoHS) in electrical and electronic equipment, the Registration, Evaluation, Authorization and restriction of Chemicals (REACH) and the disposal of Waste Electrical and Electronic Equipment (WEEE). Consult your local waste disposal authority for guidance on how properly to recycle or dispose of this product.



# CONTENTS

This manual is divided into sections covering the following topics:

<b>1. INTRODUCTION</b>	<b>5</b>
<b>2. PRODUCT OVERVIEW</b>	<b>6</b>
<b>3. AMPLIFIER CHANNELS</b>	<b>8</b>
<b>4. SIGNAL INPUT &amp; OUTPUT OVERVIEW</b>	<b>9</b>
<b>5. ORIGIN PRO AMPLIFIER WEB APP   USER INTERFACE CONFIGURATION</b>	<b>10</b>
<b>6. AMPLIFIER CONNECTIONS</b>	<b>43</b>
<b>7. AMPLIFIER OPERATION</b>	<b>48</b>
<b>8. 2RU AMPLIFIER SERIES SPECIFICATIONS</b>	<b>51</b>
<b>9. UL CERTIFICATION &amp; SAFETY AGENCY COMPLIANCE</b>	<b>54</b>
<b>10. TROUBLESHOOTING</b>	<b>58</b>
<b>11. TECHNICAL ASSISTANCE</b>	<b>58</b>
<b>12. LIMITED 5 YEAR WARRANTY</b>	<b>59</b>
<b>13. RETURN PROCESS</b>	<b>59</b>

# 1. INTRODUCTION



Thank you for purchasing an Origin PRO amplifier.

Please read this manual fully before installing and using an amplifier.

Origin PRO Amplifiers have been designed to provide configurable, consistent and reliable high performance audio power amplification for residential, commercial and entertainment applications.

This manual covers the features, installation and functions of the following models:

**ProA1000.1 • ProA1000.1D • ProA1000.2 • ProA1000.2D**

**ProA1200.1 • ProA1200.1D • ProA1200.2 • ProA1200.2D**

The following Origin PRO 1RU amplifier models:

**ProA1000.1 • ProA1000.1D • ProA1000.2 • ProA1000.2D**

**ProA1200.1 • ProA1200.1D • ProA1200.2 • ProA1200.2D**, all meet the following standards:

**UL 62368-1 & CSA C22.2 No. 62368-1:**

## **Audio/Video, Information and Communication Technology Equipment - Part 1: Safety Requirements**

This instruction booklet covers the necessary information for a smooth installation, including step-by-step instructions for installation, troubleshooting tips for any errors that may occur, and all warranty information.

We pride ourselves upon offering products with excellent sound quality, longevity, and a simple installation process.

If for any reason you experience problems, or if you have installation questions, please call us at **(844) 674-4461**. Hours of operation are 8:00am to 5:00pm (Pacific Time), Monday through Friday.

## 2. PRODUCT OVERVIEW

### 2.1. CARTON CONTENTS

Origin PRO Amplifiers are shipped in a cardboard carton containing the amplifier unit, a power cable appropriate for the sales territory, an accessory pack, and a quick start guide. The full contents are listed below.

- Amplifier unit
- Rack mount ears (Fitted) x 2
- AC Power Cable
- Euroblock 3.5mm Audio Input connector, according to channel count
- Euroblock 3.5mm GPIO socket connector
- Euroblock 5mm Audio Output connector, according to channel count
- Adhesive rubber feet x 4
- Quick Start Guide

### 2.2. AMPLIFIER DIMENSIONS & INSTALLATION

Origin PRO 2RU Amplifiers' dimensions and features are illustrated in **DIAGRAM 2A**.

These amplifiers are shipped with rack “ears” attached and are primarily intended for standard (19 inch) equipment rack installation.

If not to be installed in an equipment rack, the amplifiers can be placed free-standing on a flat surface. Adhesive rubber feet are supplied for this purpose.

Adhesive rubber feet are supplied for this purpose. It is important that any installation provides space for airflow through the ventilation apertures at the front and rear of the amplifier. This is illustrated in **DIAGRAM 2A**.

**DIAGRAM 2A**

Origin PRO 2RU Amplifier dimensions

2RU | 2 & 4 Channel Models

ProA1000.1 • ProA1000.1D • ProA1000.2 • ProA1000.2D

ProA1200.1 • ProA1200.1D • ProA1200.2 • ProA1200.2D

(Shaded area defines ventilation space.)

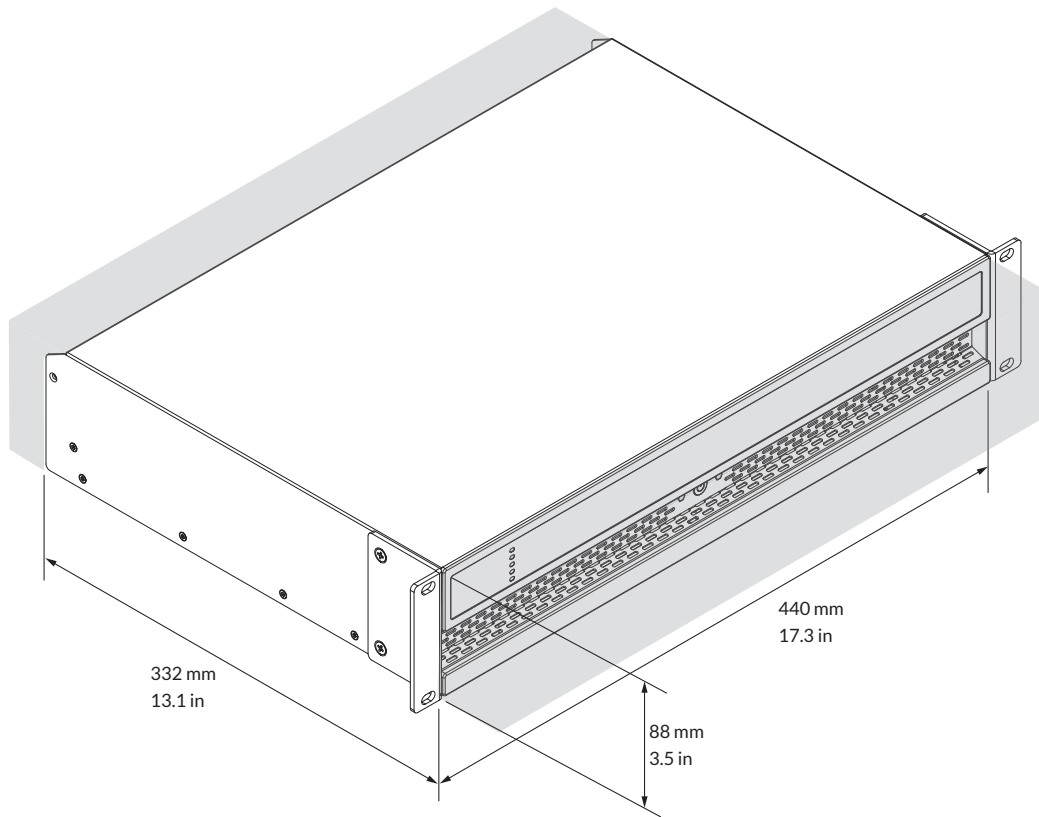

### 3. AMPLIFIER CHANNELS

These Origin Pro Amplifiers are full rack width, 2U format power amplifiers that can drive both conventional low impedance (Lo-Z, 4Ω to 8Ω) loudspeakers and high impedance (Hi-Z, 70V/100V) transformer coupled loudspeakers. They provide four analog inputs, one stereo S/PDIF digital input, and either two or four outputs (Lo-Z mode), or one or two outputs (Hi-Z or Lo-Z BTL mode).

Origin PRO Amplifiers model output channel counts and power outputs are as follows:

MODEL	MODE	CHANNELS	MAX RATED OUTPUT PER CHANNEL
<b>ProA1000.1</b>	(Lo-Z) 2Ω, 4Ω	2	500 Watts
	(Lo-Z) 8Ω	2	250 Watts
	Lo-Z (BTL) 4Ω, 8Ω	1	1000 Watts
	(Hi-Z) 70V/100V	1	1000 Watts
<b>ProA1000.2</b>	(Lo-Z) 2Ω, 4Ω	4	500 Watts
	(Lo-Z) 8Ω	4	250 Watts
	Lo-Z (BTL) 4Ω, 8Ω	2	1000 Watts
	(Hi-Z) 70V/100V	2	1000 Watts
<b>ProA1200.1</b>	(Lo-Z) 2Ω, 4Ω	2	750 Watts
	(Lo-Z) 8Ω	2	400 Watts
	Lo-Z (BTL) 4Ω, 8Ω	1	1500 Watts
	(Hi-Z) 70V/100V	1	1200/ 1500 Watts
<b>ProA1200.2</b>	(Lo-Z) 2Ω, 4Ω	4	750 Watts
	(Lo-Z) 8Ω	4	400 Watts
	Lo-Z (BTL) 4Ω, 8Ω	2	1500 Watts
	(Hi-Z) 70V/100V	2	1200/ 1500 Watts

- **ProA1000.1D:** Specifications same as ProA1000.1; with added Dante capability
- **ProA1000.2D:** Specifications same as ProA1000.2; with added Dante capability
- **ProA1200.1D:** Specifications same as ProA1200.1; with added Dante capability
- **ProA1200.2D:** Specifications same as ProA2000.2; with added Dante capability

*Note: In Lo-Z BTL (bridge-tied load) mode, two amplifier output channels are combined to create a single, double power output channel. BTL mode can be engaged via the amplifier Output Mode configuration setup menu described in Section 5 of this manual.*



## 4. SIGNAL INPUT & OUTPUT OVERVIEW

### 4.1 CONNECTIONS

Origin PRO Amplifiers signal input and output connections are accomplished via RCA Phono and Euroblock style connectors. A GPIO (General Purpose In/Out) Euroblock connector enables some amplifier functions to be controlled externally, and wireless or RJ45 socket Ethernet network connection options are also provided. Cable connectors and connections are described and illustrated in **SECTION 6** of this manual

Origin PRO Amplifiers incorporate a front panel mounted power button. Press the button once to switch the amplifier on or off. Amplifier power management behavior can be configured via the Origin PRO amplifier web app **SETTINGS** Menu described in **SECTION 5** of this manual.

### 4.2 NETWORK FEATURES

Origin PRO Amplifiers are TCP/IP network connected devices that require a wired or wireless network connection to access their configuration menus. The configuration menus are accessed via the Origin PRO™ amplifier web app interface and cover **Input, Zone, Output** and **General Settings** functions. The configuration menus are fully described in **SECTION 5** of this manual.

### 4.3 FIRMWARE

This manual describes the features, functions and user interface of Origin PRO Amplifier running:

#### Firmware Version 1.4.0.



*It is strongly recommended that the firmware version installed in the amplifier in use is checked initially, and regularly thereafter. If updated firmware is available, the amplifier should be updated as a priority.*

The firmware installed in the amplifier can be identified and updated by selecting the **Device** option in the: **Origin PRO Amplifier Web App: Settings Menu.**

Firmware versions can be checked, and firmware downloaded from:

[www.originpro.com](http://www.originpro.com).

## 5. ORIGIN PRO AMPLIFIER WEB APP | USER INTERFACE CONFIGURATION

Before making input, output and GPIO connections, an initial Origin PRO Amplifier configuration should be established. It is particularly important that the amplifier output format is configured appropriately for the speakers that are to be connected.

Configuration requires that the Origin PRO Amplifiers are connected to mains power and network services. These connections are described in the following two sections.

### 5.1 MAINS POWER CONNECTION

Origin PRO Amplifiers incorporate a power factor corrected power supply and can be used with mains input voltage from 100V AC to 240V AC, 50/60Hz. Use the mains cable supplied with the amplifier and connect it to a switched mains supply.

Press the front panel power button to switch on the amplifier. After a short delay the front panel Status indicator will illuminate green.

### 5.2 NETWORK SERVICES

Origin PRO Amplifiers are configured via a dedicated web page interface hosted by Origin PRO. Before the configuration menus can be accessed, Origin PRO Amplifiers must be connected to the same TCP/IP network as the computer or mobile device that is to be used for configuration access.

#### 5.2.1 WIRED (ETHERNET) NETWORK CONNECTION

*To connect the amplifier to a TCP/IP network using a wired connection (Ethernet) follow the steps below.*

1. Use an Ethernet cable to connect the Origin PRO Amplifier rear panel Network Control socket to a free socket on a network router or switch, or directly to an Ethernet equipped laptop or desktop computer.
2. Connect the Origin PRO Amplifier to mains power using the supplied mains cable. Wait for the front panel Network indicator to illuminate green to indicate that the amplifier has network connectivity.
3. The Origin PRO Amplifier **DEFAULT LAN IP ADDRESS** is:

**192.168.64.100**

Configure the laptop or desktop computer for a fixed IP address in the same IP range; eg. 192.168.64.10, with Subnet mask of 255.255.255.0 (or prefix 24) and **SET THE GATEWAY TO:**

**192.168.64.1**

4. Open a laptop or desktop web browser and enter the address

**http://192.168.64.100**

The Origin PRO amplifier web app interface will open to enable amplifier configuration as required.

**Note:** *Origin PRO amplifiers can be configured to use DHCP for network connection if required. However, if an Origin PRO amplifier using DHCP is power cycled, it is possible that the TCP/IP network router will assign it a different IP address, leaving its configuration page inaccessible via the previous address. If this occurs, a network scanning app can be used to identify the new IP address. DHCP and Fixed IP address option settings can be found in the Settings Tab menu described in:*

**Section 5.3 - (CONFIGURATION MENUS).**

## 5.2.2 WIRELESS (WIFI) NETWORK CONNECTION

*To connect an Origin PRO Amplifier to a TCP/IP network using a wireless connection (WiFi) follow the steps below.*

1. With the Origin PRO Amplifier connected to mains power, wait for the front panel WiFi indicator to illuminate **GREEN**.
2. Use a mobile, laptop or desktop device to search for available WiFi networks. Connect to:

**Origin PRO (product model + serial number) using the password, 'password'.**

The amplifier serial number can be found on its rear panel.

3. Open a computer or mobile device web browser and enter the IP address:

**192.168.4.1.**

The Origin PRO amplifier web app interface will open to enable amplifier configuration as required.

4. Select the **Origin PRO amplifier web app >SETTINGS TAB** followed by **WIFI > WIFI MODE > CLIENT** to configure the amplifier to connect to the required WiFi network. The WiFi network name and password will be required.

**It is strongly recommended that the Origin PRO Amplifier Access Point WiFi password is changed following initial wireless setup connection.**

## 5.3 CONFIGURATION MENUS

Opening a web browser that is network connected to an Origin PRO amplifier initially displays the **Origin PRO amplifier Dashboard** illustrated in **DIAGRAM 5A**. The Dashboard is the ‘home’ page from which all other configuration options can be accessed.

The **Dashboard** displays the amplifier **Status**, **Output Zones** and the **Configuration** menu tabs.

It also enables immediate access to **Zone Volume Control**.

The functions available under each configuration menu tab are described in the following sections.

### **DIAGRAM 5A**

**Configuration Dashboard display**

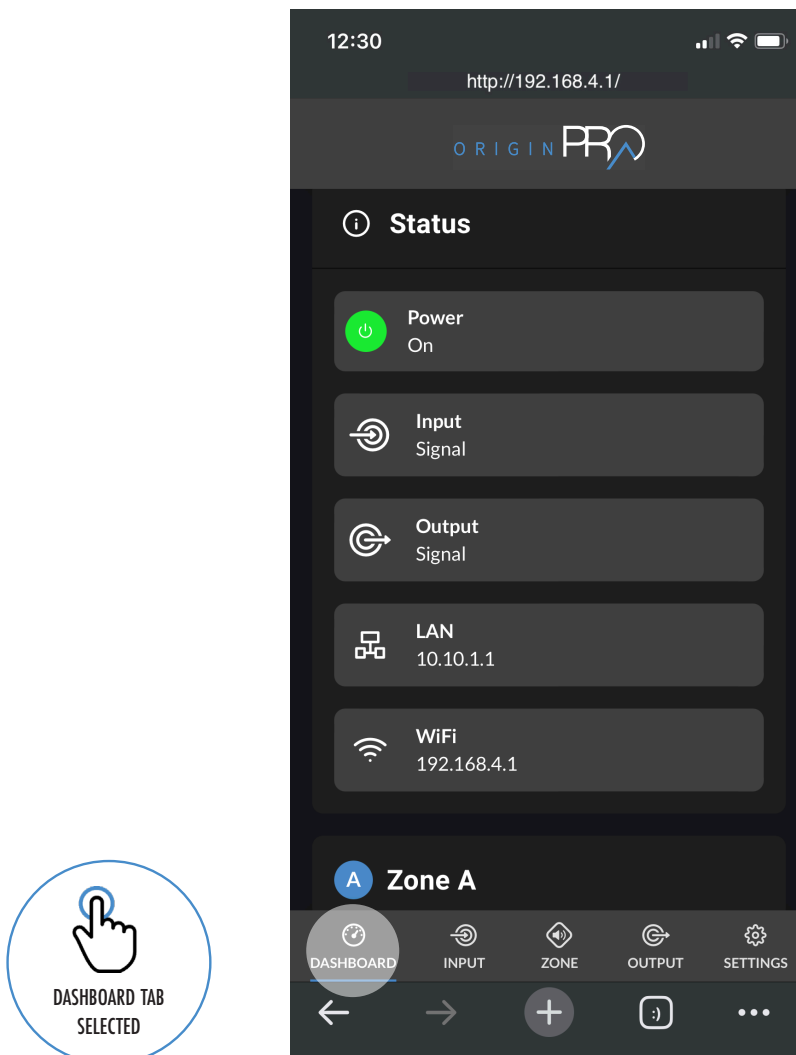

## 5.3 CONFIGURATION MENUS

### DIAGRAM 5A

Configuration Dashboard display - Continued

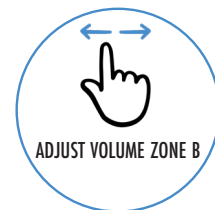
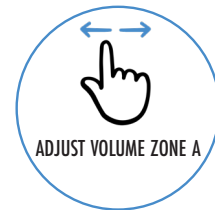
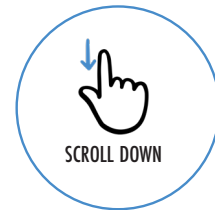
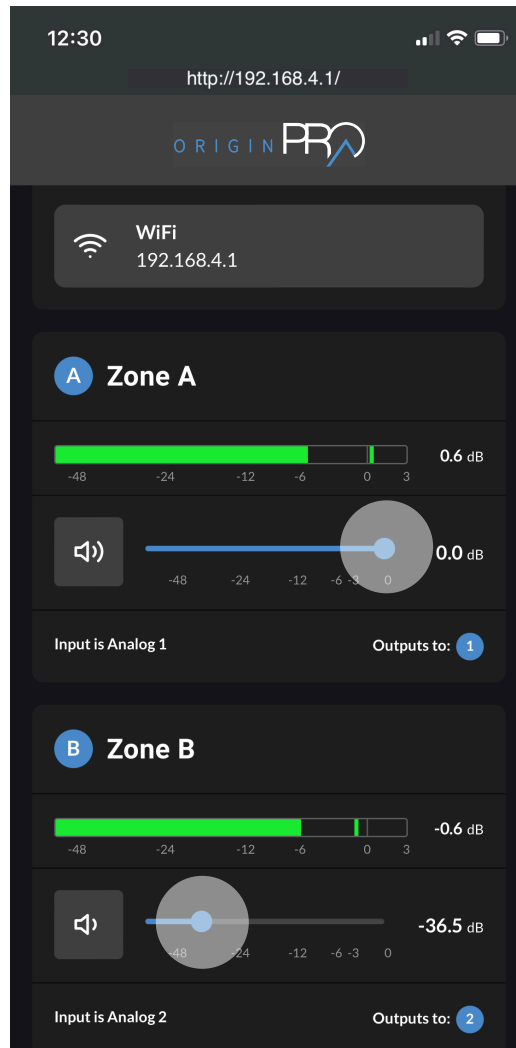

### 5.3.1 INPUT TAB

The **INPUT TAB** provides the following configuration parameters for each amplifier input channel:

- Input name
- Mono/Stereo selection
- Input sensitivity
- High-pass filter
- Gain trim
- Five band equalization

The **INPUT TAB** also enables input signals to be mixed and routed to specific amplifier zones. The mix function enables any amplifier input, including stereo or split mono S/PDIF inputs, to be grouped with any other input or inputs to create multiple predefined mixes.

**1. Note:** *The number of individual mixes possible is equal to the number of amplifier analogue inputs.*

**2. Note:** *Mix inputs are muted by default with their level adjustment sliders set to zero.*

Mix operations take place following high-pass filter, input equalization and mono/stereo selection.

**DIAGRAMS 5B, 5C and 5D illustrate the INPUT TAB, INPUT EQ and INPUT MIX displays.**

## 5.3.1 INPUT TAB

### DIAGRAM 5B

Input Tab display (Inputs 1 & 2 only shown)

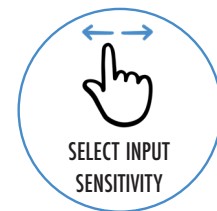
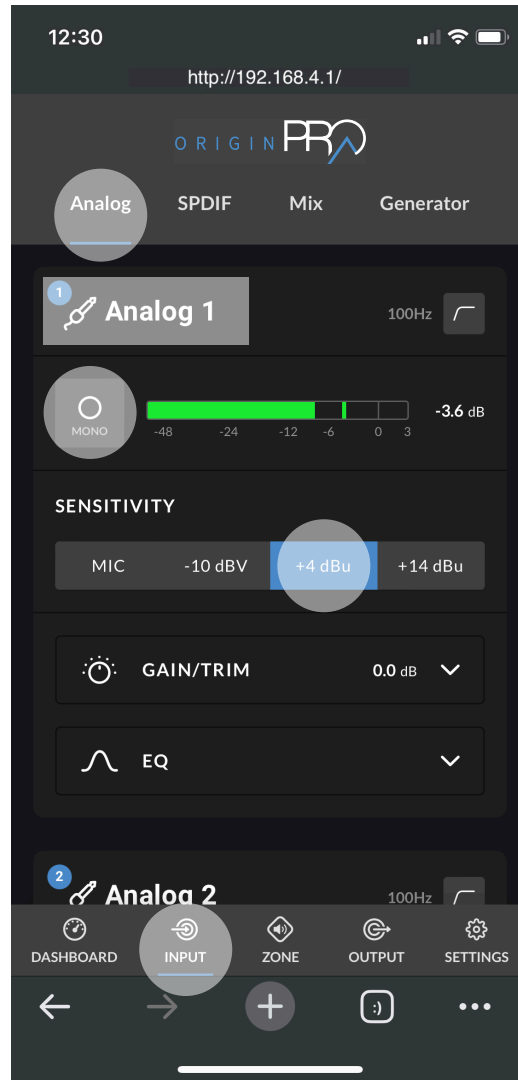
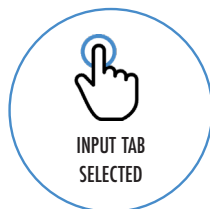
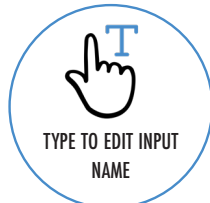
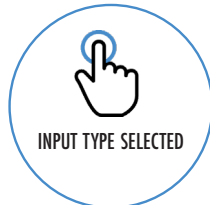

A pink noise or sine wave audio signal generator, appropriate for audio system testing and set up, can also be enabled, disabled, and adjusted for gain and frequency via the **INPUT TAB**.

## 5.3.1 INPUT TAB

### DIAGRAM 5B - Continued

Input Tab display - Continued (Inputs 2 & 3 only shown)

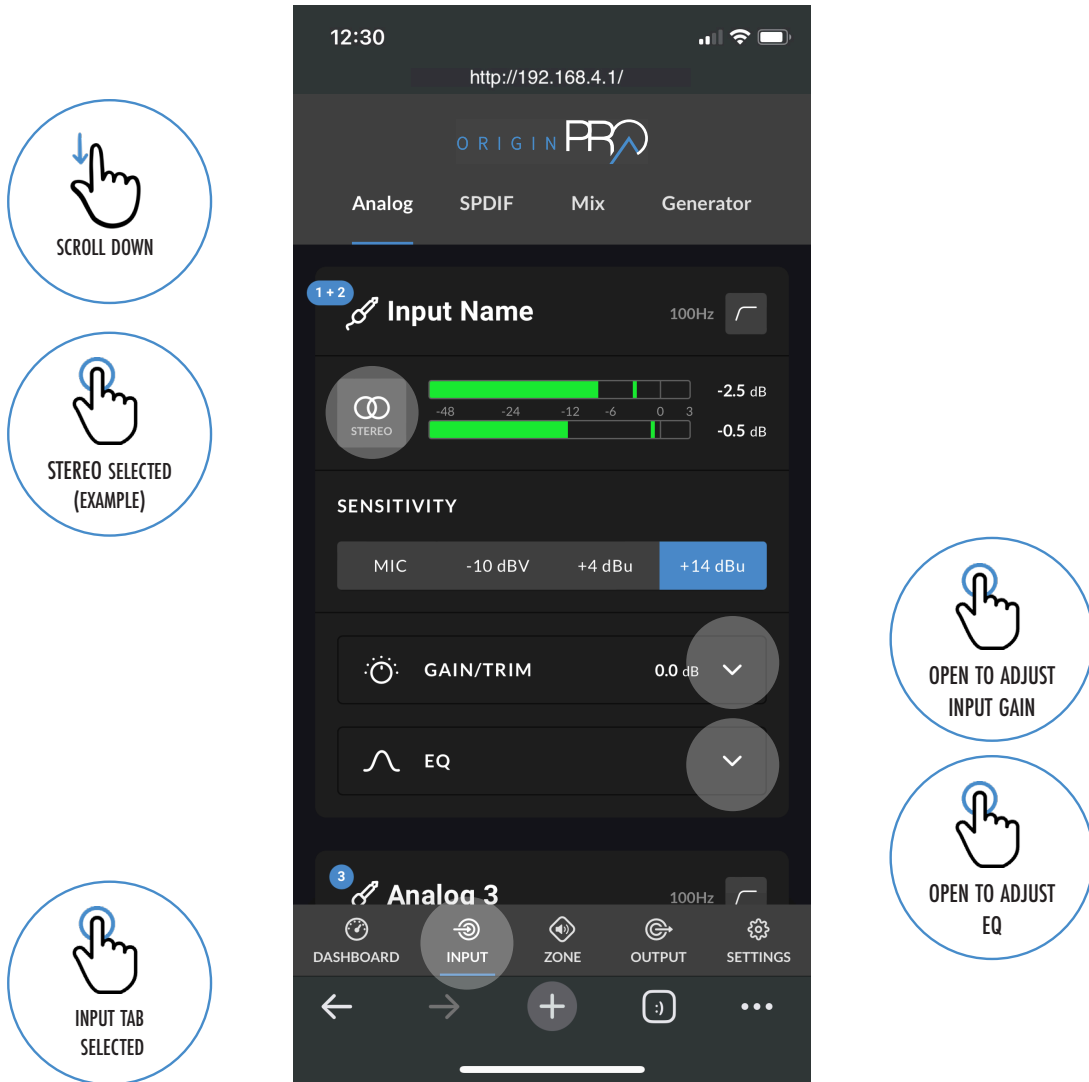

**Note:** When adjusting Input Gain, the input level display should remain GREEN. If it displays RED, the input Gain should be reduced.



## 5.3.1 INPUT TAB

### DIAGRAM 5C

Input 2 Gain/Trim & EQ display

The screenshot displays the 'Input 2 Gain/Trim & EQ' interface in the Origin Pro app. At the top, the status bar shows the time 12:30 and the URL http://192.168.4.1/. The app title 'ORIGIN PRO' is centered, with navigation tabs for 'Analog', 'SPDIF', 'Mix', and 'Generator'. Below the tabs, the 'Input Name' section shows a '1+2' indicator and a '100Hz' filter. The 'Gain/Trim [dB]' section features a slider with a green level indicator, showing values from -48 to 3 dB, with the current setting at 0.0 dB. The 'EQ' section includes a frequency response graph with a green line and five stage selectors (1-5), with stage 1 selected. Three callout icons are overlaid: 'ADJUST REQUIRED EQ STAGES' (top left), 'REQUIRED EQ STAGES SELECTED' (bottom left), and 'ADJUST INPUT GAIN' (right side).

**Note:** When adjusting Input Gain, the input level display should remain GREEN. If it displays RED, the input Gain should be reduced.

## 5.3.1 INPUT TAB

### DIAGRAM 5D

#### Input Mix display

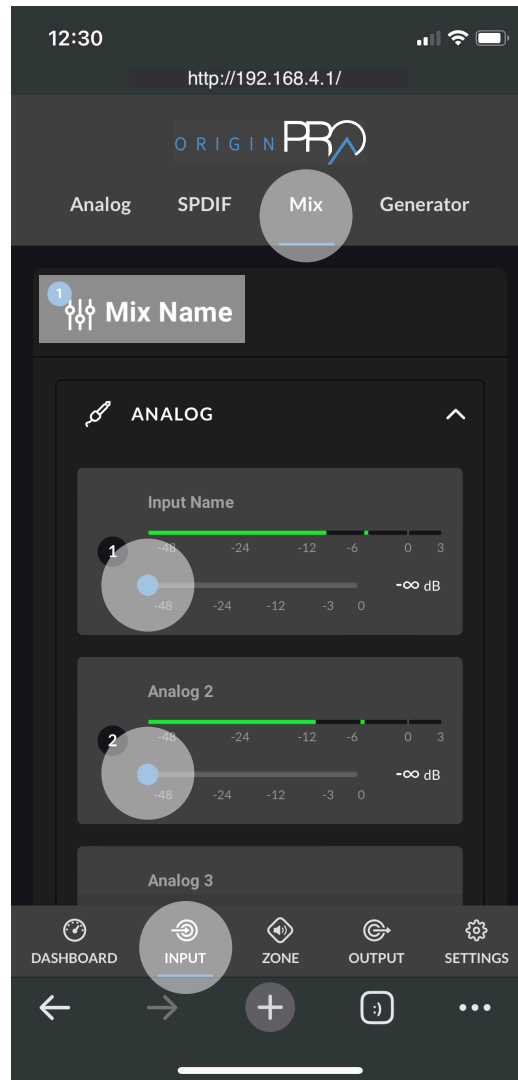
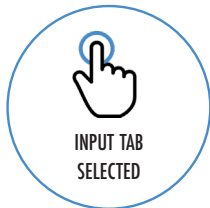
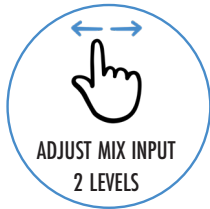
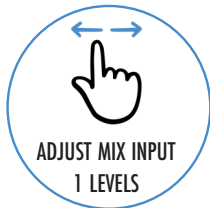

## 5.3.2 ZONE TAB

The **ZONE TAB** enables installation zones to be defined and named, and provides access to further sub-menus.

- Zones might be bar or restaurant areas for example, or different rooms in a home. For all **Zone Tab** menus, the installation zone under configuration is selected by highlighting one of the zone identifiers (A, B, C or D) at the top of the display.

**DIAGRAM 5E AND 5F** illustrates the **ZONE TAB** and **SOURCE** Menu displays.

- The Source menu enables inputs to be assigned to zones and **INPUT PRIORITY** or **INPUT DUCKING** to be configured. The **INPUT PRIORITY** function enables an alternative input to replace and mute the input primarily routed to the zone under configuration when the alternative input exceeds a preset level.

- The **INPUT DUCKING** function enables an alternative input to replace and attenuate the input primarily routed to the zone under configuration when the alternative input exceeds a preset level.

**Note:** *Input Priority and Input Ducking parameters can be either set to default values or their Threshold, Attack, Hold and Release values set as required. Input Priority can also be set to ignore the volume level set for the specified zone and take a specific override volume.*

## 5.3.2 ZONE TAB

### DIAGRAM 5E

Zone Tab display



SELECT ZONE INPUT →

CONFIGURE ZONE VOLUME OPTIONS →

CONFIGURE ZONE RESTRICTIONS →

CONFIGURE ZONE COMPRESSOR →

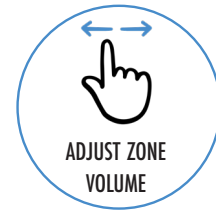
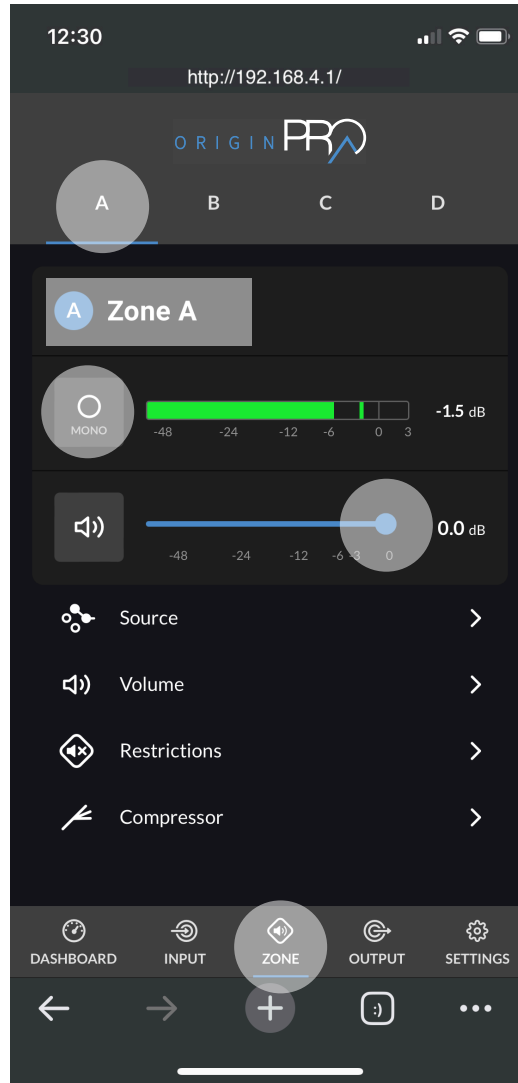

## 5.3.2 ZONE TAB

### DIAGRAM 5F

Zone Source menu display

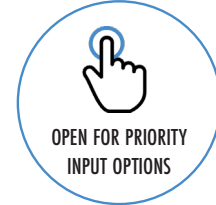
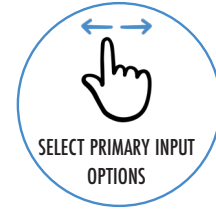
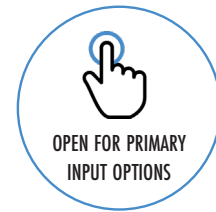
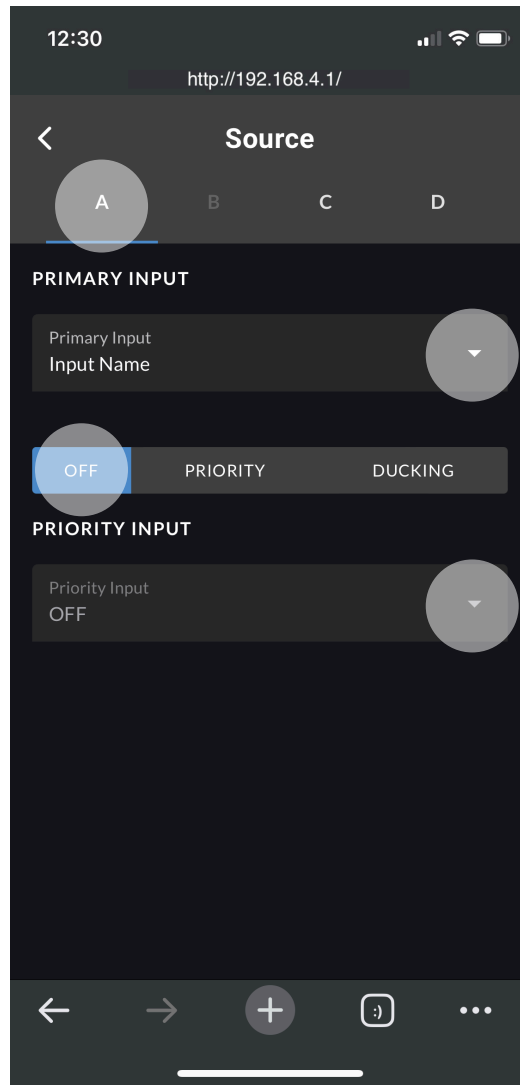

- The **VOLUME MENU** allows minimum and maximum zone volume limits to be set, and enables external **GPIO** volume control to be applied to individual zones. The **GPIO** configuration menu can be found under the **SETTINGS TAB**, and notes on connecting an external volume control via the **GPIO** interface can be found in **Section 5.5** of this manual.

**Note:** *If an amplifier is controlled via a third-party control system API, volume level limits set via the Input Tab will not apply.*

- The **RESTRICTIONS** menu enables zone inputs or input mixes to be restricted from routing to particular zones.

**Note:** *Routing restrictions cannot be applied to priority zone inputs.*

**Note:** *If an amplifier is controlled via a third-party control system API, input routing restrictions set via the Input Tab will not apply.*

- The **COMPRESSOR** option enables default or custom signal compression to be applied to individual zones.

**Note:** *Compression can be useful to reduce the volume difference between loud and quiet audio material. The lower the compression threshold is set, the more the difference between loud and soft will be reduced. The overall zone volume may need to be increased when compression is used. The default compression parameters are appropriate for most installations.*

### 5.3.3 OUTPUT TAB

The **OUTPUT TAB** enables amplifier outputs to be named, linked to zones, and provides access to **DELAY, EQUALIZER** and **SPEAKER PRESET** menus.

- **DIAGRAM 5G** illustrates the **OUTPUT TAB** display.

- For all **OUTPUT TAB** menus, the amplifier output under configuration is selected by highlighting one of the output identifiers (1, 2, 3 or 4) at the top of the display.

**Note:** *The number of individual outputs available for configuration will depend on the amplifier model and the input, zone and output mode configuration.*

• The **ROUTING** menu enables zones to be assigned to amplifier outputs.

**Note:** *Routing for zones specified as stereo will automatically offer three output options: left channel, right channel or summed mono. The summed mono signal can potentially be used to drive a mono subwoofer.*

• The **DELAY** menu enables delay to be applied to individual amplifier outputs.

### 5.3.3 OUTPUT TAB

#### DIAGRAM 5G

Output Tab display

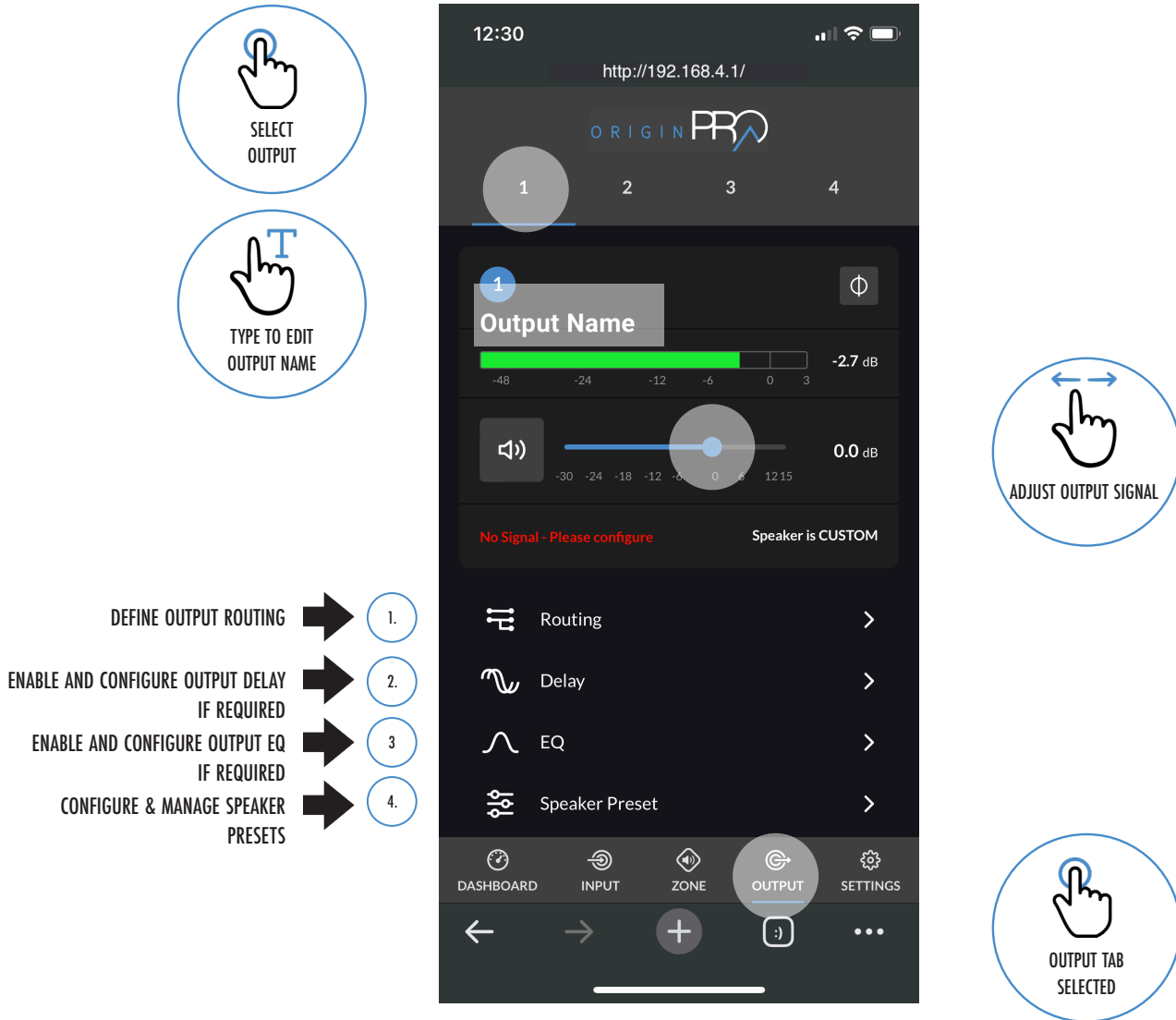



### 5.3.3 OUTPUT TAB

#### 1. OUTPUT ROUTING MENU

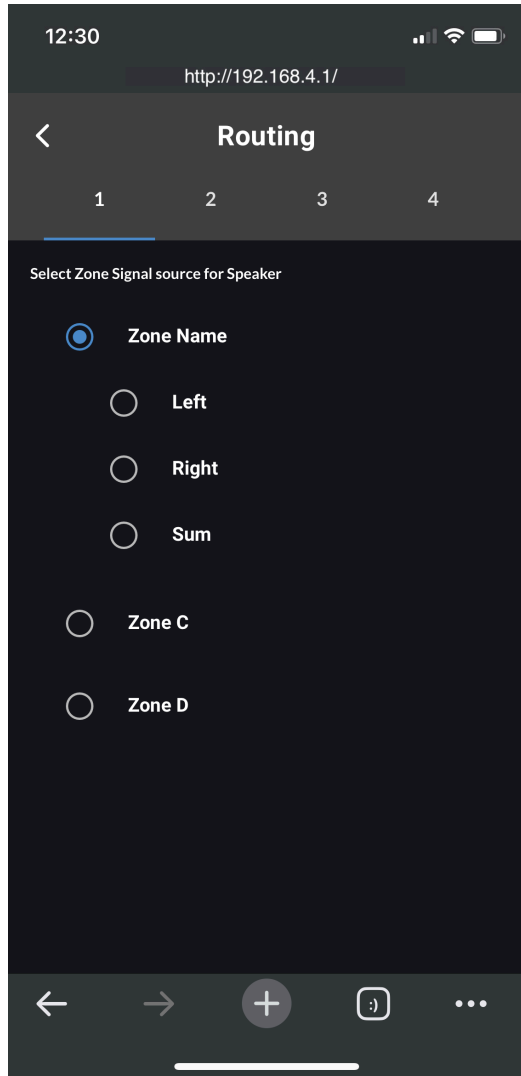

#### 2. OUTPUT DELAY MENU

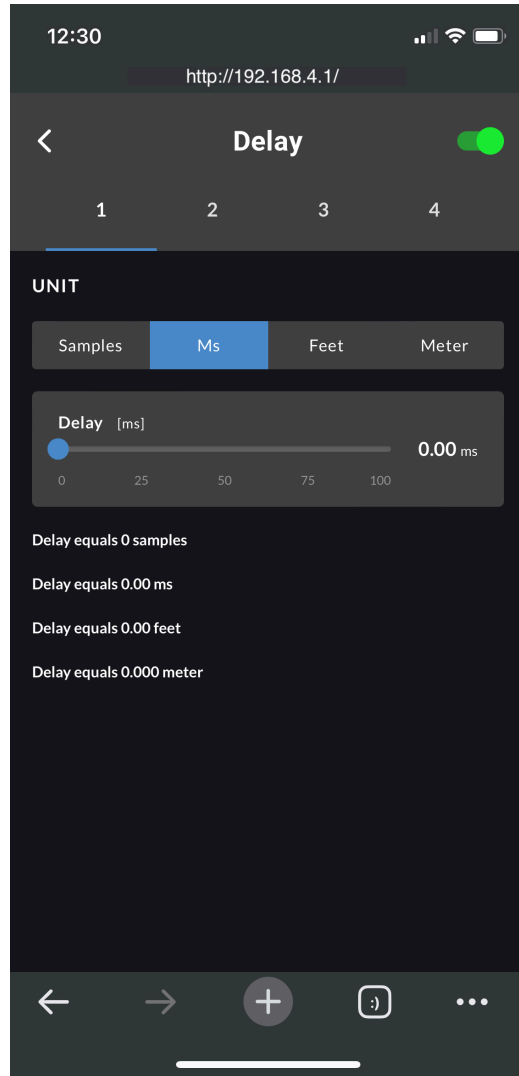

### 5.3.3 OUTPUT TAB

#### 3. OUTPUT EQ MENU

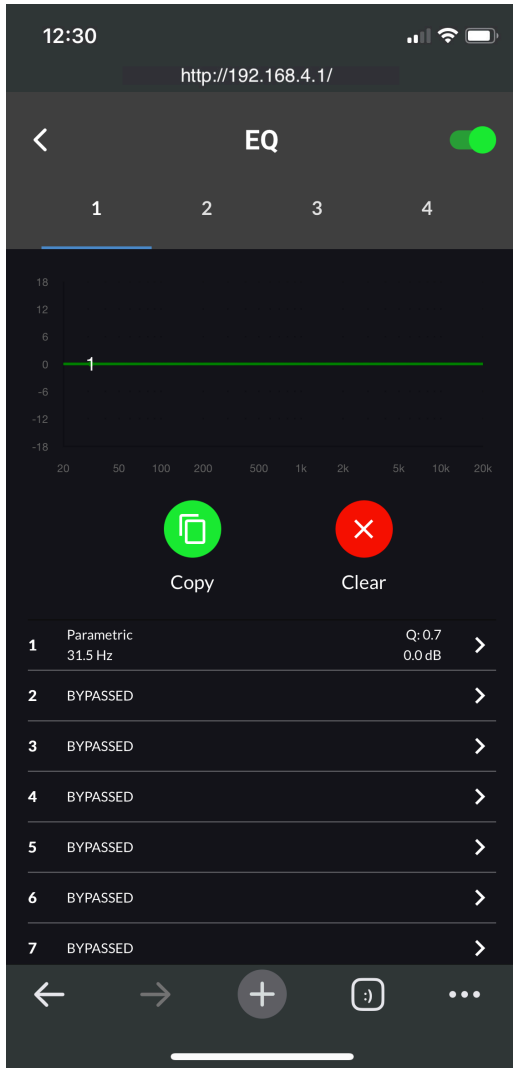

#### 4. SPEAKER PRESET MENU

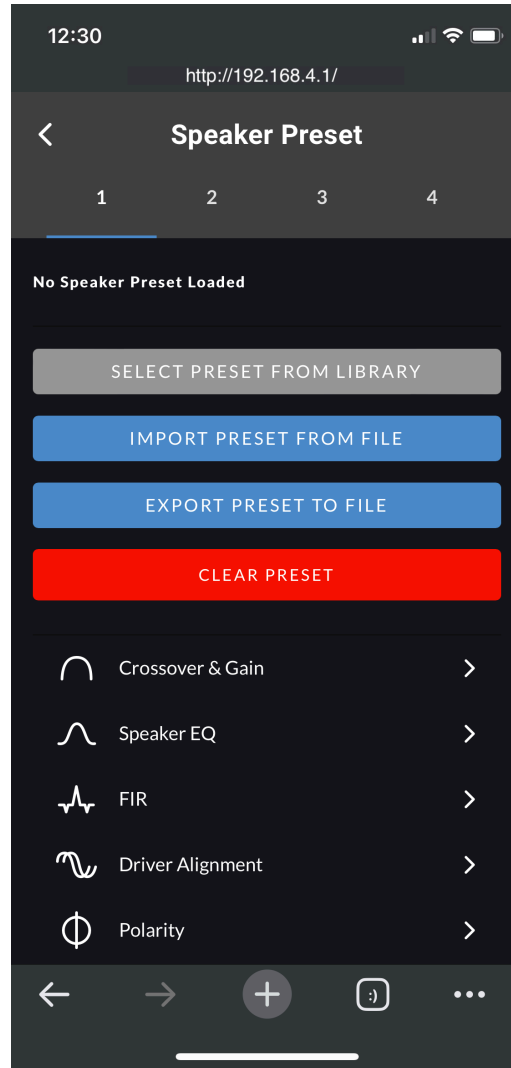

- The **EQUALIZER** menu enables parametric equalization to be applied to individual amplifier outputs. Equalizer settings configured for one amplifier output can be copied and applied to other outputs.

- The **SPEAKER PRESET** menu enables a set of speaker parameters to be adjusted, and preset configurations to be created, exported, imported or cleared.

- Speaker Presets can be simply applied to the selected amplifier output or imported, chosen from a library, exported or cleared.

The preset configurations can include any or all of the parameters described in **Section 5.3.4** and can be locked to prevent inadvertent modification. **DIAGRAMS 5H** to **5J** illustrate the application of speaker presets.

- Speaker Preset data provided by third parties for use with specific speakers can be imported and applied to amplifier outputs. To import speaker preset parameters follow the steps described below and illustrated in the diagrams.

1. Select either the **IMPORT PRESET FROM LIBRARY** or **SELECT PRESET FROM FILE** option from the **SPEAKER PRESET** menu. If no import option is visible, select **CLEAR** to delete any existing speaker preset data.

**Note:** *The **SELECT PRESET FROM LIBRARY** option will be unavailable if no speaker preset libraries have been created.*

*Speaker preset library creation and management is described in Section 5.3.5.*

2. Select the appropriate '.zcp' format speaker preset data file to import from either a Library or a computer folder. The preset data will be applied to the selected amplifier output as soon as the file import is complete.

3. If the Speaker Preset data requires modification it can be customized by selecting the **CUSTOMIZE PRESET** option.

**Note:** *If an imported Speaker Preset data file includes locked parameters, they will be unavailable for modification.*

### 5.3.3 OUTPUT TAB

#### DIAGRAM 5H

#### Speaker Preset Parameters

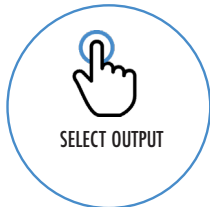

SELECT TO CONFIGURE →

SELECT TO CONFIGURE →

SELECT TO CONFIGURE →

SELECT TO CONFIGURE →

SELECT TO CONFIGURE →



\*LIMITER, OUTPUT MODE

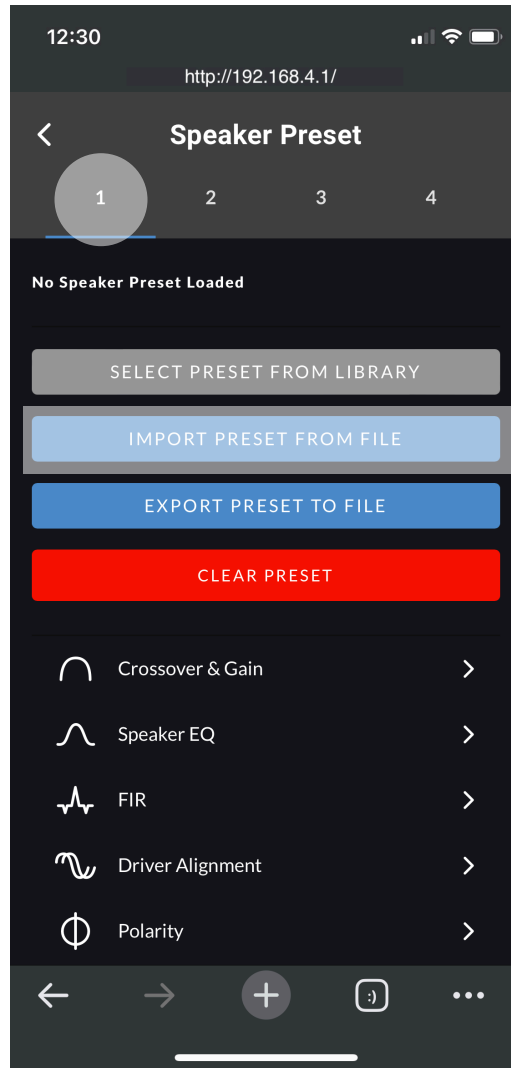

### 5.3.3 OUTPUT TAB

#### DIAGRAM 5I

#### Speaker Preset: Import File Selection

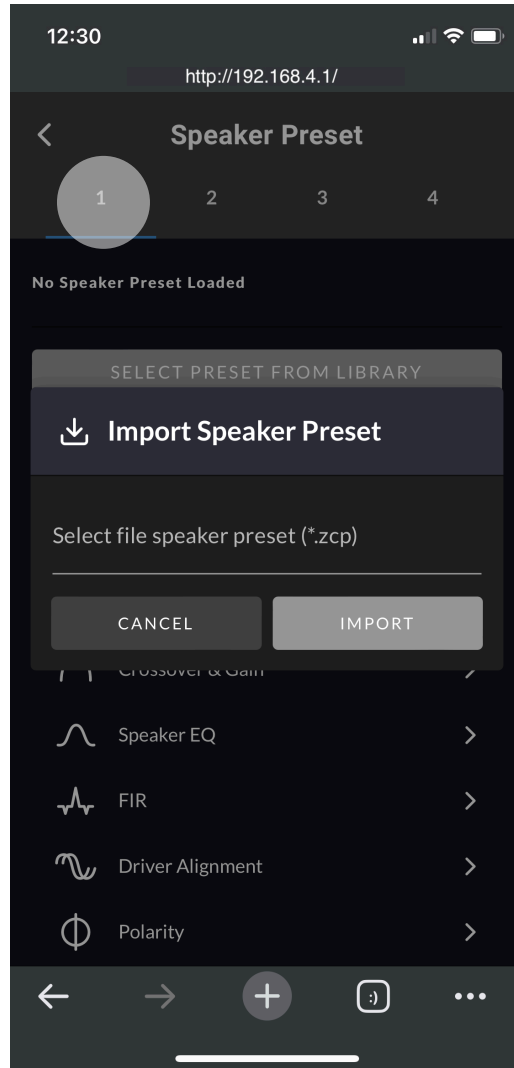
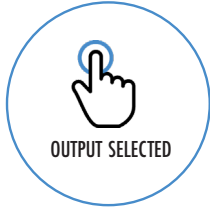

### 5.3.3 OUTPUT TAB

#### DIAGRAM 5J

#### Speaker Preset EQ Parameter Adjustment

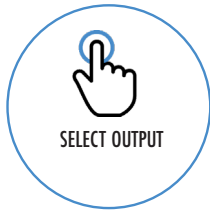

SELECT TO CONFIGURE →

SELECT TO CONFIGURE →

SELECT TO CONFIGURE →

SELECT TO CONFIGURE →

SELECT TO CONFIGURE →

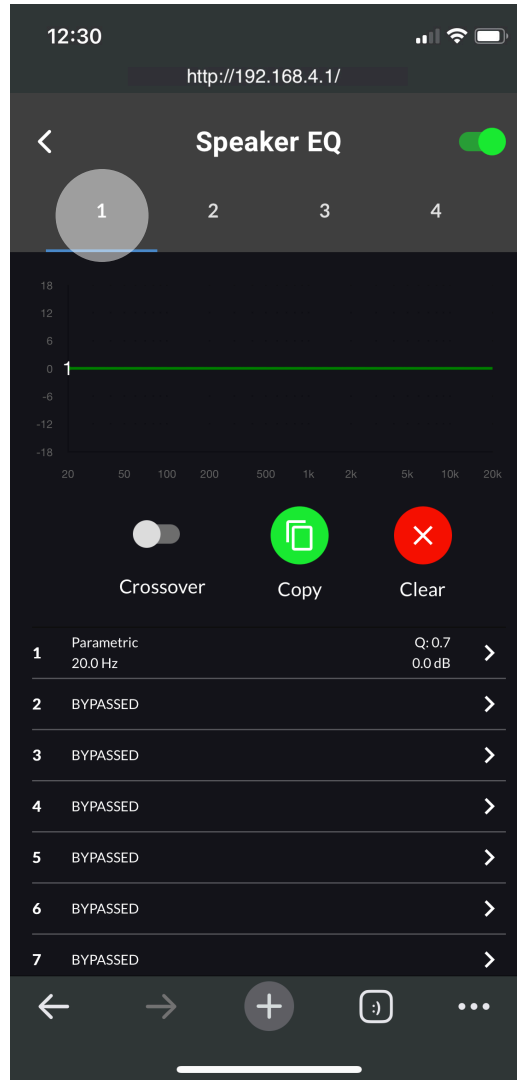
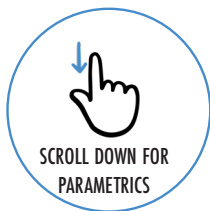

### 5.3.4 SPEAKER PRESET MENU PARAMETERS

- The **CROSSOVER & GAIN** preset menu enables high or low-pass crossover filters and gain adjustment to be applied to individual amplifier outputs.
- The **SPEAKER EQ** preset menu enables parametric equalization to be applied to individual amplifier outputs.
- The **FIR** preset menu enables **FIR (Finite Impulse Response)** based equalization filter coefficients generated by external speaker measurement software to be imported and applied to individual amplifier outputs.

**Note:** *FIR coefficient files in either .csv or .txt format can be imported.*

- The **DRIVER ALIGNMENT** preset menu enables delay to be applied to individual amplifier outputs.
- The **POLARITY** preset menu enables the polarity of individual amplifier outputs to be reversed.
- The **LIMITER** preset menu enables signal limiting to be engaged or bypassed on individual amplifier outputs.

**CLIP** limiting, **PEAK** limiting and **RMS** limiting can be individually or collectively engaged. The Clip limiting function offers Fast and Normal response time options. The Peak limiting function can be set to either Automatic or Manual parameter values. The RMS Limiter has default parameter values that can be adjusted but has no automatic option.

**Note:** *It is strongly advised that if an amplifier is driving low impedance loads (<4Ω):*

*the Clip Limiter should be engaged and set to Fast.*

**Note:** *In automatic mode:*

*the peak limiter parameters adjust automatically in response to Crossover & Gain high-pass filter settings.*

- The **OUTPUT MODE** preset menu enables individual amplifier outputs to be switched off or configured for Lo-Z or Hi-Z modes. In Hi-Z modes, a high-pass filter can also be configured and applied to the output. The number of outputs available will depend on the amplifier model, input setup and zone setup. For example, a two output amplifier will have two outputs available if Lo-Z mode is selected but only one output available if Hi-Z mode is selected.

**Note:** *Use of a high-pass filter with Hi-Z mode loudspeakers is useful to avoid the possibility of distortion caused by low frequency line transformer saturation. Begin with the default filter setting of 70Hz. If low frequency distortion is still audible, increase the frequency setting one step at a time until the distortion is no longer audible.*

### 5.3.5 SETTINGS TAB

The **SETTINGS TAB** enables miscellaneous amplifier settings to be configured and installation data to be recorded. The Settings Tab provides access to further sub-menus. **Diagram 5L** illustrates the **SETTINGS TAB**.

- The **SYSTEM INFORMATION** menu provides text fields for the recording of installation data.
- The **DEVICE** menu records amplifier specific information such as the model number and firmware version. A firmware update routine and identifier button can also be found under the Device menu. **Diagram 5M** illustrates this **FIRMWARE UPDATE** button.
- The **EXTERNAL DEVICES** menu enables control panels to be paired with an amplifier and configured. Each individual amplifier zone to be controlled will require its own control device.
- The **BACKUP & RESTORE** menu enables amplifier configuration data to be downloaded to an external archive, and enables previously saved configuration files to be uploaded and adopted by the currently connected amplifier.
- The **SPEAKER LIBRARY** menu enables management of speaker preset libraries. Existing libraries of speaker preset files (.zcl) can be created or imported, and existing libraries edited or fully deleted. **Diagrams 5N & O** illustrate the creation and management of speaker preset libraries.
- The **SECURITY** menu enables a password to be set in order to protect against unauthorized access to the Origin PRO amplifier web app.

*Password protection is particularly important when an amplifier is connected to a wired network, as the WiFi password is no longer required to gain access to Origin PRO amplifier web app.\**

*\* **NOTE:** It is recommended that your Origin PRO amplifier web app password is different from the amplifier's Wi-Fi Access Password.*



## 5.3.5 SETTINGS TAB

### DIAGRAM 5L

#### Settings Tab Menu

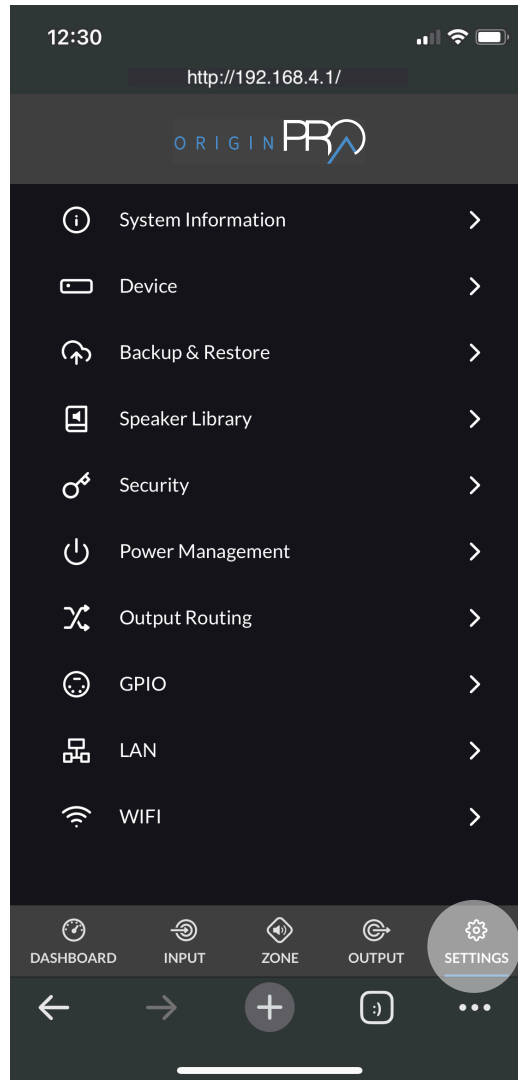

## 5.3.5 SETTINGS TAB

### DIAGRAM 5M

FIRMWARE UPDATE selection button, found inside Device Menu

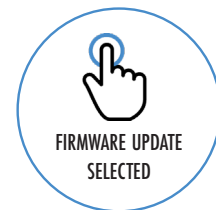
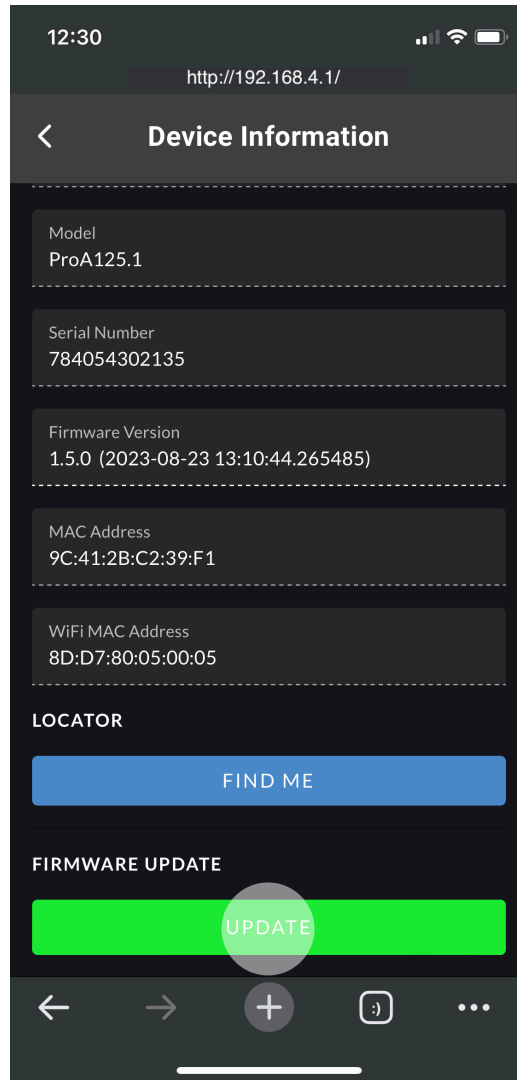

## 5.3.5 SETTINGS TAB

### DIAGRAM 5N

#### Speaker Library Creation and Management

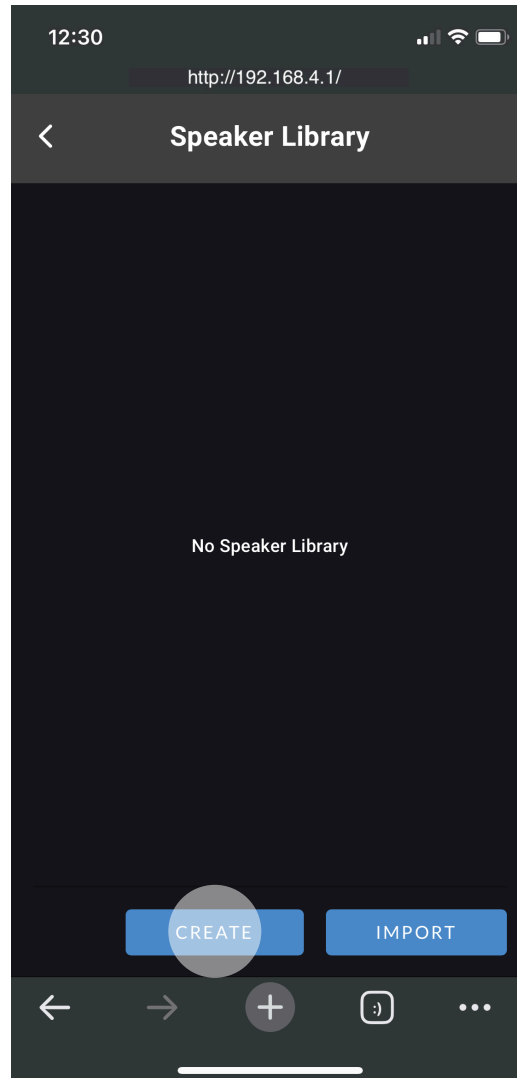

## 5.3.5 SETTINGS TAB

### DIAGRAM 50

#### Speaker Library Import Option

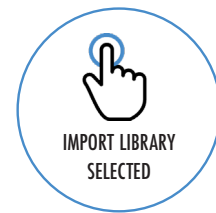
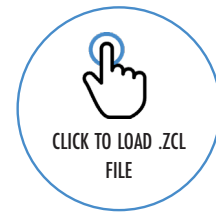
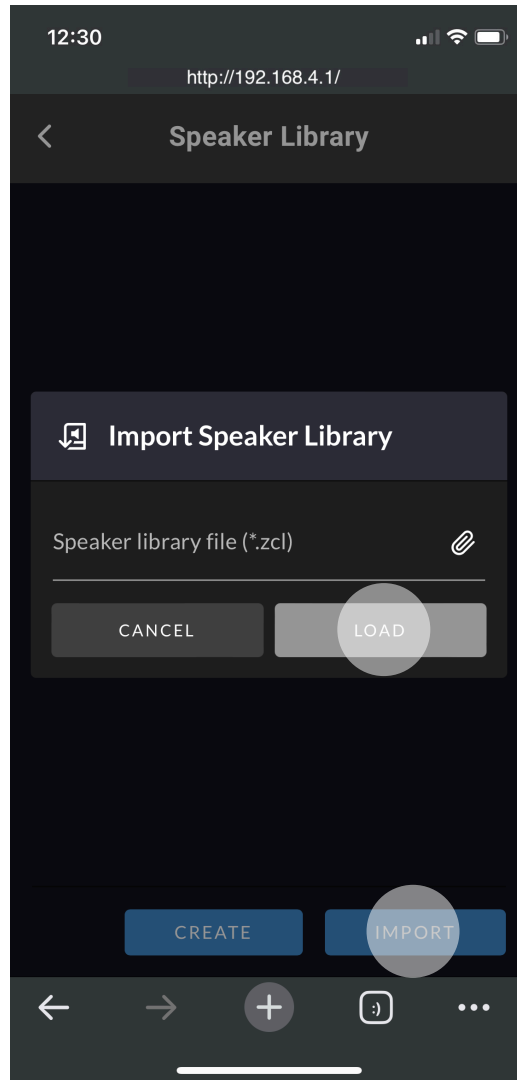

- The **POWER MANAGEMENT** menu enables various automatic switch-on options to be engaged.

The Power Management menu also offers timed **Standby** and **Mute** functions.

- The **OUTPUT ROUTING** menu enables specified inputs or zones to be routed to the amplifier S/PDIF outputs. The output level can also be adjusted.

Any zone or input can be routed to either digital output, including inputs not actively assigned to a zone. Primary or priority input status is immaterial. The specified input is always routed to the specified output to be available for use by downstream devices.

***Note:** The digital output function is especially useful when amplifiers are to be daisy chained and a specific input; a central paging mic, for example, is required to be routed to multiple amplifiers.*

- The **GPIO** menu enables configuration of the multi-purpose GPIO interface pins.
- The **LAN** menu enables configuration and reset of the wired network options and parameters.
- The **WIFI** menu enables configuration and reset of the wireless network options and parameters.

## 5.4 SETUP AND SIGNAL ROUTING

Thanks to their network based configuration features, Origin PRO amplifiers offer considerable versatility in terms of sources, signal routing, installation zones and output modes.

Inputs can be freely assigned to installation zones, and those zones assigned freely to the available amplifier outputs in either Lo-Z or Hi-Z modes. This versatility enables, for example, one amplifier simultaneously to drive both Lo-Z and Hi-Z speakers, or for different inputs to be routed to different output zones.

The following paragraphs describe and illustrate the recommended procedure for configuring input, zone and output routing.

A general signal flow schematic is also illustrated in **DIAGRAM 50**.

### DIAGRAM 50

Signal Flow Schematic (four output amplifier)

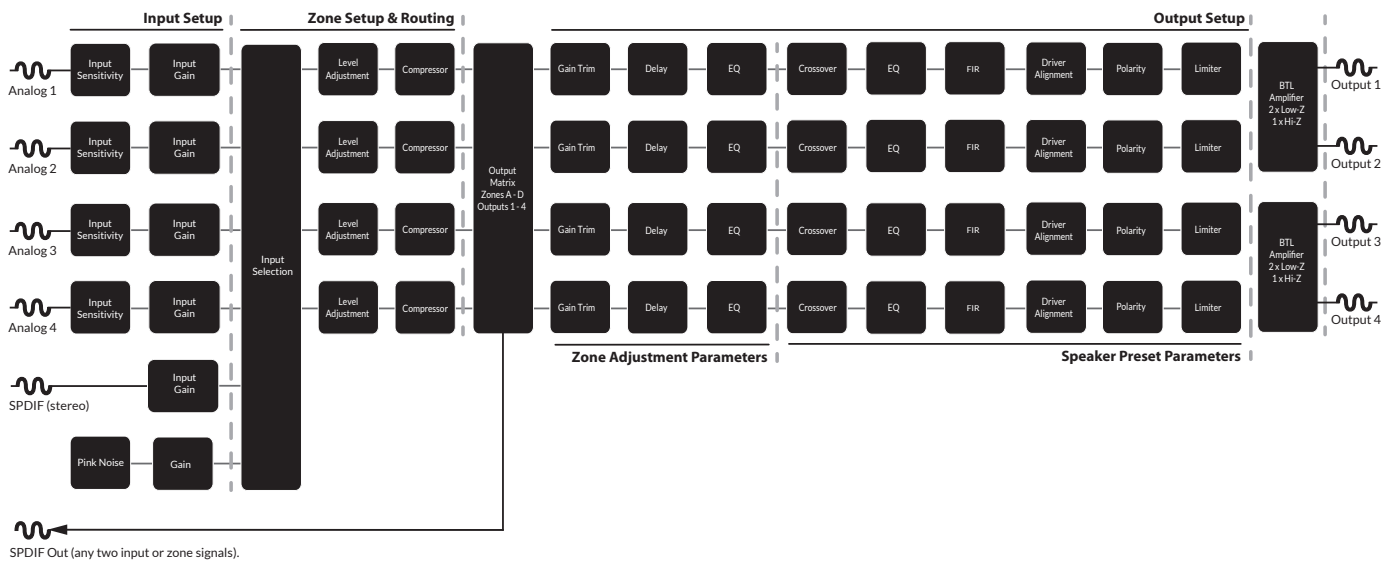

## 5.4.1 INPUT SETUP

Open the configuration **Dashboard** and select the **Input Tab**. The **Input Tab** was shown previously in **DIAGRAM 5B**.

- To edit default input names simply select and type in the Input Name field.
- Define a mono or stereo input by selecting the appropriate option. Defining a stereo input will reduce the total number of discrete inputs available.
- Select an input sensitivity option from the drop-down menu: **+14dB**, **+4dB**, **-10dB** and 'microphone' options are available.
  - Generally, the **+14dB** or **+4dB** options are appropriate for 'professional audio' source hardware with balanced outputs, while the **-10dB** option is more appropriate for 'consumer audio' source hardware with unbalanced outputs.
  - The 'microphone' option provides the significantly greater sensitivity required for microphones.

**NOTE:** *Only dynamic microphones are suitable for connection. Phantom power for condenser microphones is not provided.*

- If necessary, adjust the input gain using the slider or up/down icons. Gain adjustment is intended to be used for fine output level adjustment following initial use.

## 5.4.2 ZONE SETUP & ROUTING

Open the configuration **Dashboard** and select the **Zone Tab**. The **Zone Tab** was shown previously in **DIAGRAM 5E**.

- Select the zone to be configured. The number of zones available and their channel format (stereo or mono) will depend on the amplifier model, input setup and output mode (Lo-Z or Hi-Z).

**For example, a two output amplifier can have the following zone configurations:**

- 1 x stereo Lo-Z zone
- 2 x mono Lo-Z zones
- 1 x mono Hi-Z zone

**A four output amplifier can have the following zones configured:**

- 2 x stereo Lo-Z zones
- 4 x mono Lo-Z zones
- 2 x mono Hi-Z zone
- 1 x mono Hi-Z zone + 1 x stereo Lo-Z zone
- 1 x mono Hi-Z zone + 2 x mono Lo-Z zones

**1. Note:** When configured in Hi-Z mode Origin PRO amplifiers operate in 'bridged' mode where the output of two channels is combined. This means that the number of output channels available in Hi-Z mode is half that available in Lo-Z mode.





**2. Note:** Mono signals might be mono at source, created though combining the left and right channels of a stereo signal (summed mono) or treating the left and right channels of a stereo signal independently (split mono).

- Name zones by typing in the Zone Name field.
- Adjust the zone volume if required by using the slider.
- Define a mono or stereo zone by selecting the appropriate option. Defining a stereo zone will reduce the total number of further zones available.
- Specify an input for the zone by selecting from the drop-down menu. Selecting a stereo input for a mono zone will automatically sum the stereo channels to mono.



## 5.5 GPIO SETUP AND CONNECTION

Origin PRO amplifiers provide a GPIO socket that enables remote control of volume, standby, mute and trigger functions. The GPIO connector pin functions are described in the GPIO Settings menu illustrated in **DIAGRAM 5P**. The connection of GPIO based remote volume control and standby/mute are illustrated in **DIAGRAM 5Q** and **DIAGRAM 5R** respectively.

-  **1. Note: The GPIO connector must not be used for any unintended purpose. Amplifier damage may result from incorrect use of GPIO.**
-  **2. Note: Shielded cable must be used when connecting standby switches and potentiometers via GPIO.**
-  **3. Note: GPIO Pin 8 has a low output impedance and is able to supply a maximum current of 10mA.**
-  **4. Note: GPIO Pin 1 and Pin 3 both offer ground connections: Pin 1 is connected directly to the amplifier chassis. Pin 3 is connected to the chassis via a 220 Ohm resistor. The ‘soft ground’ connection of Pin 3 is potentially useful for managing ground loops that may cause audible hum.**

**DIAGRAM 5P**

### GPIO Settings Menu

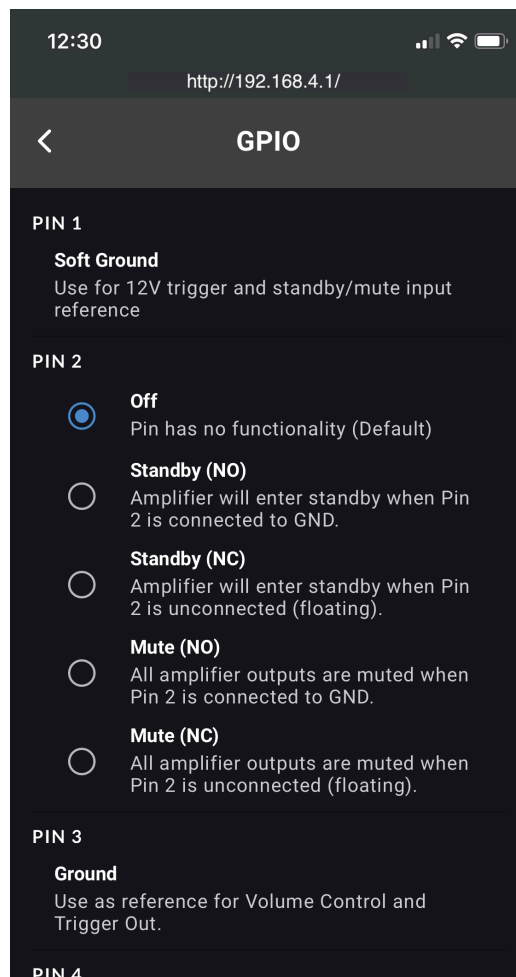
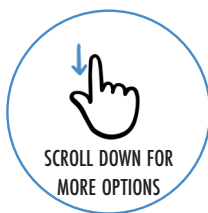

### DIAGRAM 5Q

Potentiometer connections for remote volume control via GPIO.

Note: Diagram 6D illustrates use of the GPIO connector.

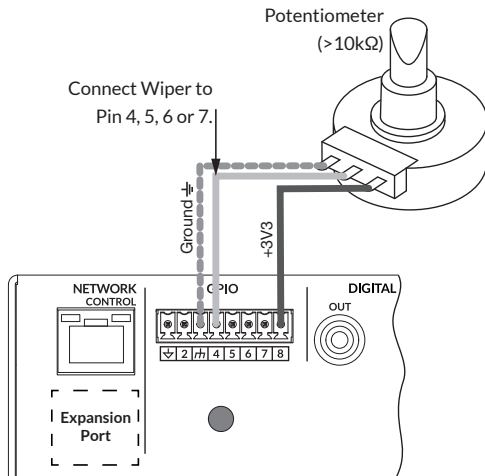

### DIAGRAM 5R

Connections for remote standby/mute switch via GPIO.

Note: Diagram 6D illustrates use of the GPIO connector.

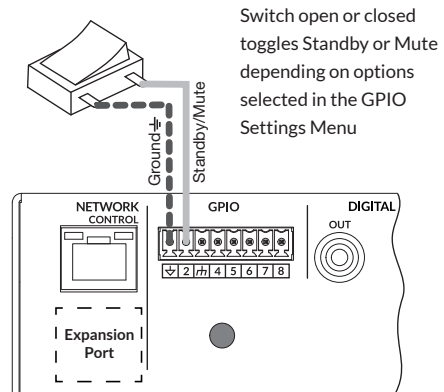

## 6. AMPLIFIER CONNECTIONS

Origin PRO amplifier rear panel connections are illustrated in **DIAGRAM 6A**.

### DIAGRAM 6A

Origin PRO amplifiers rear panel connections.

**Note:** Two output amplifier model connection sockets differ only in the deletion of channel 3 and channel 4 output connectors.

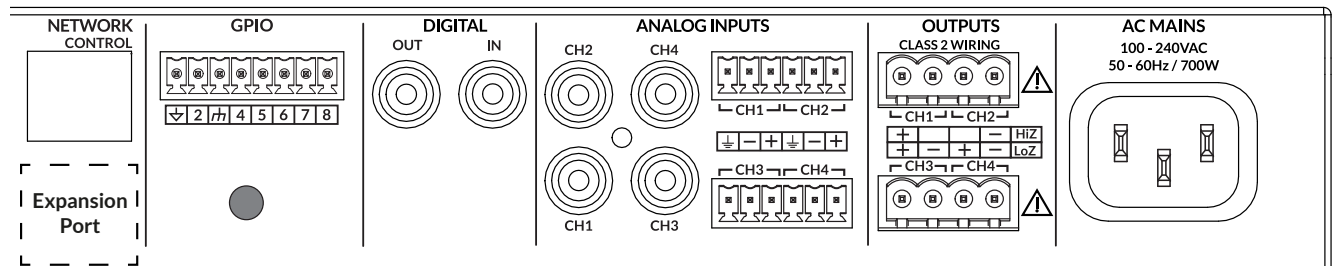

### 6.1 MAINS POWER CONNECTION

Origin PRO amplifiers incorporate a power factor corrected universal power supply and can be used with mains input voltage from 100V AC to 240V AC, 50/60Hz. Use the mains cable supplied with the amplifier.

These 2 RU amplifiers incorporate a front panel mounted power button. Press the button once to switch the amplifier on or off.

**Ensure that all signal, GPIO and output connections are made before connecting the amplifier to mains power.**

### 6.2 INPUT CONNECTION

All Origin PRO amplifiers models provide four balanced or unbalanced analog audio inputs and a stereo S/PDIF digital audio input.

Any input channel can be routed to any output channel. Input routing options can be configured via the **Origin PRO amplifier**

**web app Input Tab**. See **Section 5.3.1** of this manual.

#### • ANALOG INPUTS

Origin PRO amplifiers analog inputs are of line level format with a default input sensitivity of **+4dBu** (full output voltage swing/sensitivity) in all output modes. Input signal levels up to **+24dBu** can be handled without input clipping. Input sensitivity options can be set via the amplifier network interface. See **Section 5** of this manual.

Balanced input connections to the amplifiers are made via male 'Euro Block' connectors. Connecting cables to the supplied female input connectors is illustrated in **DIAGRAM 6B**.

Unbalanced input connections to the amplifiers are made via RCA phono sockets connected in parallel with the balanced inputs.

## • DIGITAL OUTPUTS

Origin PRO amplifiers' S/PDIF stereo digital audio output connections are made via a single RCA Phono socket. The S/PDIF output signal can be routed from any input or zone and is intended to be used for daisy-chaining Origin PRO amplifiers.

**1. NOTE:** See the *Output Routing paragraphs of Section 5.3.3 for more information on Digital Output configuration.*

**2. NOTE:** *75Ω RCA Phono cables specifically intended for digital audio should always be used for S/PDIF connections.*

*Standard Phono cables can be used but may not result in optimal performance.*

**3. NOTE:** *The S/PDIF output level is by default set at -10dB to reduce the possibility of downstream input clipping.*

## 6. 3 OUTPUT CONNECTIONS

Output connections from the amplifiers are achieved via male 'Euro Block' connectors. Ensure that speaker connection polarity is correct throughout the installation:

- In the case of Lo-Z speaker connections, positive (+) amplifier terminals should always be connected to positive speaker terminals and negative (-) amplifier terminals always connected to negative speaker terminals.

- In the case of Hi-Z speaker connections, the two speaker cable conductors should be connected between the positive (+) terminal of Output 1 and the negative terminal (-) of Output 2, and likewise for Outputs 3 and 4.

Output mode options (Lo-Z or Hi-Z) can be configured via the **Origin PRO amplifier web app Input Tab**.

See **SECTION 5** of this manual.

Connecting cables to the supplied female output connector is illustrated in **DIAGRAM 6C**.

## 6.4 GPIO CONNECTIONS

If any Origin PRO amplifier's GPIO functionality is required, cables will need to be connected to the supplied GPIO connector.

Connecting cables to the GPIO connector is illustrated in **DIAGRAM 6D**.

## 6.5 REAR PANEL CONNECTIONS

### DIAGRAM 6B

Balanced analog INPUT cable connections.

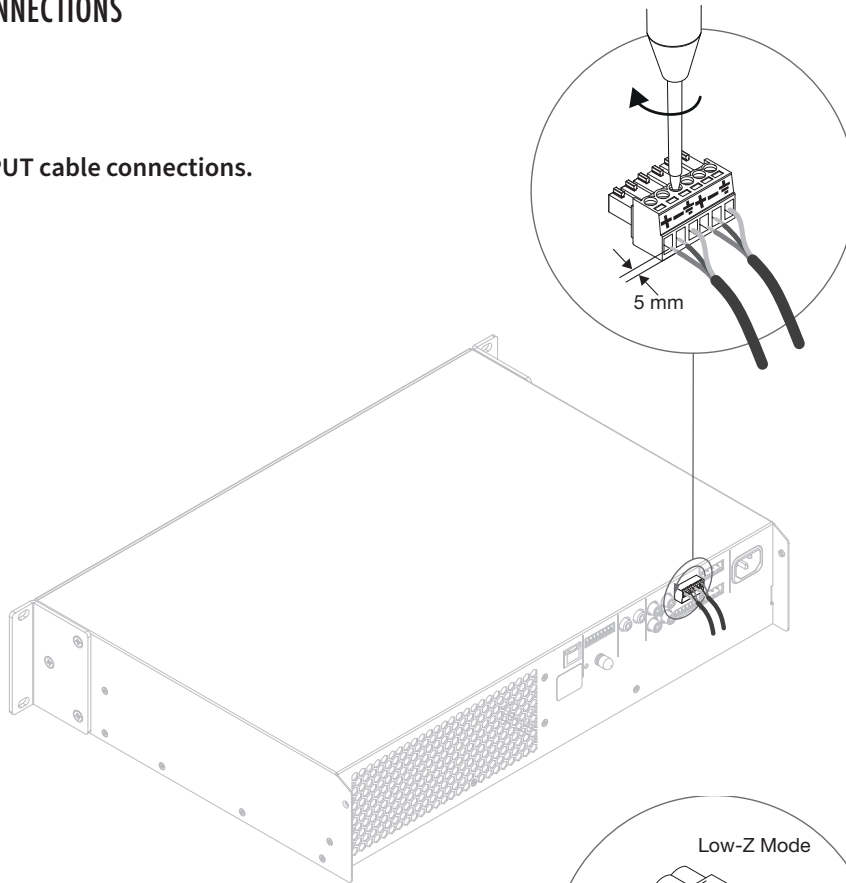

### DIAGRAM 6C

OUTPUT cable connections.

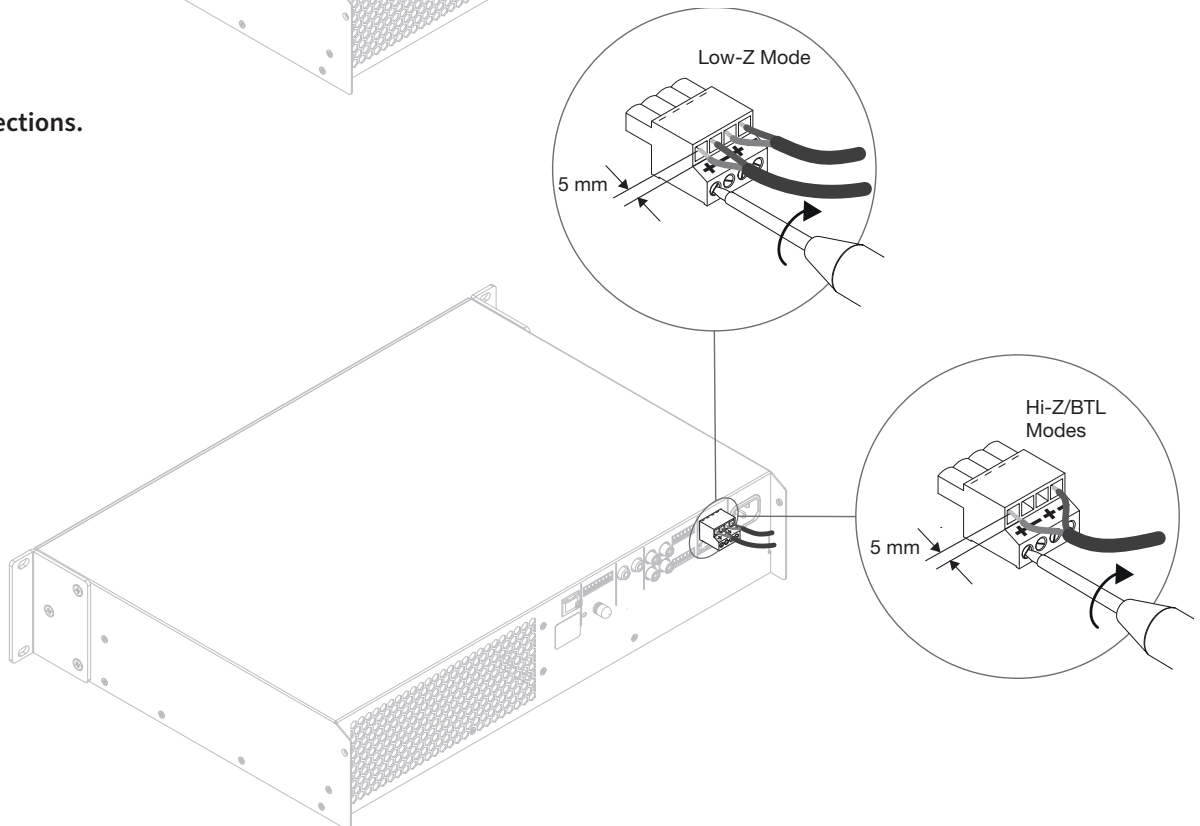

*The exclamation point printed next to the output terminals of the amplifiers is, in addition to the CLASS 2 WIRING text, intended to alert users to the risk of hazardous voltages.*



*Output connectors that could pose a risk are marked with the exclamation point.*

*Do not touch the output terminals while the amplifier is switched on.*

*Make all connections with the amplifier switched off.*

## 6.5 REAR PANEL CONNECTIONS

### **DIAGRAM 6D**

GPIO cable connections.

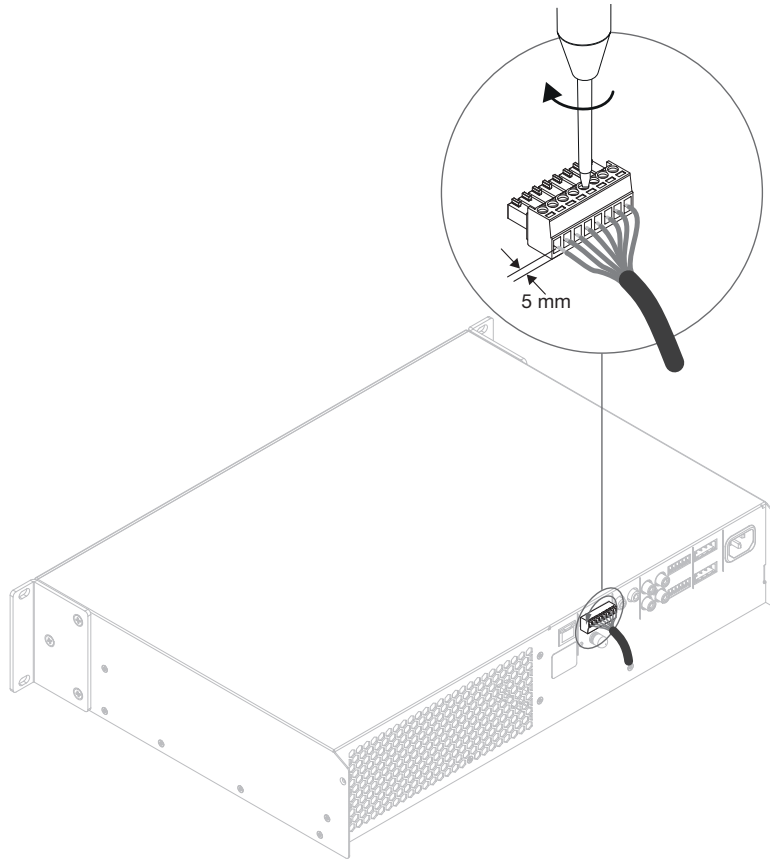

*The exclamation point printed next to the output terminals of the amplifiers is, in addition to the CLASS 2 WIRING text, intended to alert users to the risk of hazardous voltages.*



*Output connectors that could pose a risk are marked with the exclamation point.*

*Do not touch the output terminals while the amplifier is switched on.*

*Make all connections with the amplifier switched off.*

## 6.6 NETWORK CONNECTIONS

Origin PRO amplifiers are TCP/IP network connected devices that are configured via a web page based interface. Wired (Ethernet) and wireless (WiFi) connection options are available. Connecting Origin PRO amplifiers to a TCP/IP network is described in

**SECTION 5** of this manual.

## 6.7 SPEAKER CABLE GAUGE

Origin PRO amplifiers speaker connection cable gauge should be chosen appropriately to reflect the type of installation. The following tables specify the appropriate cable gauge for less than 0.5dB cable loss in Lo-Z mode and less than 1.0dB cable loss in Hi-Z mode.

### **Cable Gauge Table: Lo-Z Installations, 0.5dB attenuation, 2Ω, 4Ω & 8Ω loads**

Cable Cross Section (mm <sup>2</sup> )	Cable Gauge (AWG)	MAX Cable Length (2Ω load)	MAX Cable Length (8Ω load)	MAX Cable Length (8Ω load)
0.75	=18	N/A	5m / 16.4 ft	10m / 32.8 ft
1.5	=16	5m / 16.4 ft	10m / 32.8 ft	20m / 65.5 ft
2.5	=14	8m / 26 ft	17m / 55.7 ft	35m / 114.8 ft
4.0	=12	14m / 46 ft	28m / 91.8 ft	55m / 180.4 ft

### **Cable Gauge Table: 70V Hi-Z Installations, 1.0dB attenuation, 20 speakers evenly distributed**

Cable Cross Section (mm <sup>2</sup> )	Cable Gauge (AWG)	MAX Cable Length (1000W/ch)	MAX Cable Length (1200W/ch)
0.75	=18	25m / 82 ft	20m / 65.5 ft
1.5	=16	50m / 164 ft	40m / 131.2 ft
2.0	=14	80m / 262.5 ft	60m / 196.8 ft
3.5	=12	125m / 410 ft	100m / 262.5 ft

**Note: The cable lengths should not exceed 250m/820 ft.**

### **Cable Gauge Table: 100V Hi-Z Installations, 1.0dB attenuation, 20 speakers evenly distributed**

Cable Cross Section (mm <sup>2</sup> )	Cable Gauge (AWG)	MAX Cable Length (1000W/ch)	MAX Cable Length (1200W/ch)
0.75	=18	190m / 623.3 ft	90m / 295.2 ft
1.5	=16	<250m / 820.2 ft	180m / 590.5 ft
2.0	=14	<250m / 820.2 ft	<250m / 820.2 ft
3.5	=12	<250m / 820.2 ft	<250m / 820.2 ft

**Note: The cable lengths should not exceed 250m/820 ft.**

## 7. AMPLIFIER OPERATION

Once all connections have been made and configuration options selected, Origin PRO amplifiers are ready for use.

If an input signal above -60dB is present on any input, the front panel **Input** and **Standby** indicators will illuminate green to indicate normal amplifier operation. Audio will be heard from any connected speakers.

**Note:** *Origin PRO amplifiers will not switch on from Standby Mode unless an input signal is present, a network 'ON' command is received, or an external standby switch (or 12V trigger) is operated. Standby behavior can be configured via the: **Power Management Menu of the Origin PRO amplifier web app Settings Tab.***

Amplifier outputs will mute if no input signal is present for **5 minutes**.

The amplifier will switch automatically to **Standby Mode\***,

if no signal is present on any input for more than **15 minutes**.

Alternative standby and mute delay times can be selected via the **Settings Tab**.

\*Amplifier cooling fan speed is temperature controlled. The fan will switch off when the amplifier enters standby mode.



## 7.1 FRONT PANEL INDICATORS

Origin PRO amplifier front panel indicators illuminate to indicate the following operational states:

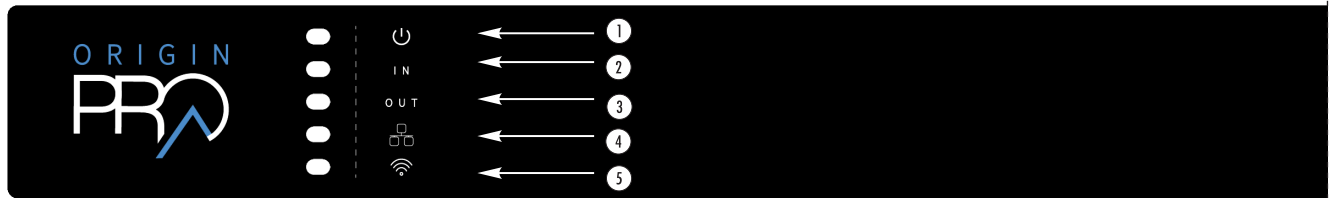

### 1 STATUS:



**Green** – Amplifier operational.



**Pulse Green** – Standby Mode.



**Amber** – GPIO triggered Standby Mode

**Off** – Mains power disconnected.



### 2 INPUT:



**Green** – Signal present on one or more inputs.



**Amber** – Signal limiting/Clipping on one or more inputs.

**Off** – No input signal present.



### 3 OUTPUT:



**Green** – Signal present on one or more outputs.



**Amber** – Signal limiting/Clipping on one or more outputs.



**Red** – One or more channel pair is in overload/protection mode.

**Off** – No input signal present.



### 4 NETWORK:



**Green** – Ethernet network detected.

**Off** – No Ethernet network detected.

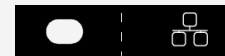

### 5 WIFI:



**Green** – WiFi enabled.

**Off** – WiFi disabled.



## 7.2 DEFAULT RESET

Origin PRO 2 RU amplifiers can be returned to their default settings via either:

- the Origin PRO amplifier web app: Settings Tab

or

- through the Front Panel Power button.

To reset the amplifier using the **Front Panel Power button**, follow the steps below:

- Disconnect the amplifier from mains power.
- Press and hold the front panel power button while simultaneously reconnecting mains power.
- Continue to hold the front panel power button for 3 to 5 seconds as the amplifier restarts.

The amplifier will restart with all settings at their default state. Any previously configured settings will be deleted.

## 8. 2RU SERIES AMPLIFIER SPECIFICATIONS | ProA1000 MODELS

Model   Channels	ProA1000.1 (2 x Lo-Z   1 x Hi-Z)	ProA1000.2 (4 x Lo-Z   2 x Hi-Z)
Output Power @ 2Ω	2 x 500 W (SE)*	4 x 500 W (SE)
Output Power @ 4Ω	2 x 500 W (SE) 1 x 1000 W (BTL)**	4 x 500 W (SE) 2 x 1000 W (BTL)
Output Power @ 8Ω	2 x 250 W (SE) 1 x 1000 W (BTL)	4 x 250 W (SE) 2 x 1000 W (BTL)
Output Power @ 70V	1 x 1000 W (BTL)	2 x 1000 W (BTL)
Output Power @ 100V	1 x 1000 W (BTL)	2 x 1000 W (BTL)
Total System Power	1000 W	2000 W
Power Consumption (W)	350	700
Idle Power consumption (mW)	<500	<500
Standby Power consumption (W)	13.1	23.2
Thermal Loss [BTU/h]	167	327
Output Voltage	45 Vrms (SE unloaded) 90 Vrms (BTL unloaded)	45 Vrms (SE unloaded) 90 Vrms (BTL unloaded)
Weight	5.9 kg	7.4 kg

**ProA1000.1D** | Specifications same as **ProA1000.1**, With Dante Capabilities

**ProA1000.2D** | Specifications same as **ProA1000.2**, With Dante Capabilities

\*SE – conventional, single ended output mode

\*\*BTL – bridge-tied load output mode

## 8. 2RU SERIES AMPLIFIER SPECIFICATIONS | ProA1200 MODELS

Model   Channels	ProA1200.1 (2 x Lo-Z   1 x Hi-Z)	ProA1200.2 (4 x Lo-Z   2 x Hi-Z)
Output Power @ 2Ω	2 x 750 W (SE)	4 x 750 W (SE)
Output Power @ 4Ω	2 x 750 W (SE) 1 x 1500 W (BTL)	4 x 750 W (SE) 2 x 1500 W (BTL)
Output Power @ 8Ω	2 x 400 W (SE) 1 x 1500 W (BTL)	4 x 400 W (SE) 2 x 1500 W (BTL)
Output Power @ 70V	1 x 1200 W (BTL)	2 x 1200 W (BTL)
Output Power @ 100V	1 x 1500 W (BTL)	2 x 1500 W (BTL)
Total System Power	1500W	3000 W
Power Consumption (W)	350	700
Idle Power consumption (mW)	<500	<500
Standby Power consumption (W)	13.1	23.2
Thermal Loss [BTU/h]	203	419
Output Voltage	55 Vrms (SE unloaded) 110 Vrms (BTL unloaded)	55 Vrms (SE unloaded) 110 Vrms (BTL unloaded)
Weight	5.9 kg	7.4 kg

**ProA1200.1D** | Specifications same as **ProA1200.1** , With Dante Capabilities

**ProA1200.2D** | Specifications same as **ProA1200.2** , With Dante Capabilities

## 8. 2RU SERIES AMPLIFIER SPECIFICATIONS: ALL MODELS

<b>Dimensions</b>	88 x 440 x 332 mm (3.5 x 17.3 x 13.1 in)
<b>Output Circuitry</b>	UMAC™ Class D - full bandwidth PWM modulator with ultra-low distortion
<b>Signal To Noise-Ratio</b>	>108 dB (A-weighted, 20 Hz-20 kHz, 8 Ω load)
<b>THD+N (typical)</b>	< 0.05 % (20 Hz-20 kHz, 8 Ω load, 3 dB below rated power)
<b>Frequency Response</b>	20 Hz-20 kHz (+0/-0.5 dB (8 Ω load, 3 dB below rated power)
<b>Protection Circuits</b>	Short circuit -, DC -, Undervoltage -, Temperature - and Overload protection
<b>Power Supply</b>	UREC™ universal mains switch mode power supply with Power Factor Correction (PFC) and standby converter
<b>Operating temperature</b>	0-40°C
<b>Operating Voltage/Frequency</b>	Universal Mains, 100V-240V, 50Hz-60Hz
<b>Standby Consumption</b>	< 0.5W
<b>Accessories</b>	2 x Rack ears 4 x Adhesive Feet
<b>Power Ratings</b>	1 % THD @ 120 Vac and 230 Vac

## 9. UL CERTIFICATIONS & SAFETY AGENCY COMPLIANCE

The following Origin PRO 2RU amplifier models: **ProA1000.1 • ProA1000.1D • ProA1000.2 • ProA1000.2D • ProA1200.1 • ProA1200.1D • ProA1200.2 • ProA1200.2D**, all meet the following standards:

**UL 62368-1 & CSA C22.2 No. 62368-1:**



### **Audio/Video, Information and Communication Technology Equipment - Part 1: Safety Requirements**

*See below for Scope:*

#### **1. Scope**

This part of IEC 62368 is applicable to the safety of electrical and electronic equipment within the field of audio, video, information and communication technology, and business and office machines with a rated voltage not exceeding 600 V. This standard does not include requirements for performance or functional characteristics of equipment. NOTE 1 Examples of equipment within the scope of this standard are given in Annex a. NOTE 2 A Rated Voltage of 600 V is considered to include equipment rated 400/690 V.

This part of IEC 62368 is also applicable to: - components and subassemblies intended for incorporation in this equipment. Such components and subassemblies need not comply with every requirement of the standard, provided that the complete equipment, incorporating such components and subassemblies, does comply; - external power supply units intended to supply other equipment within the scope of this part of IEC 62368; - accessories intended to be used with equipment within the scope of this part of IEC 62368.

This part of IEC 62368 does not apply to power supply systems which are not an integral part of the equipment, such as motor-generator sets, battery backup systems and distribution transformers.

This part of IEC 62328 specifies safeguards for ordinary persons, instructed persons, and skilled persons. Additional requirements may apply for equipment that is clearly designed or intended for use by children or specifically attractive to children. NOTE 3 In Australia, the work conducted by an INSTRUCTED PERSON or a SKILLED PERSON may require formal licensing from regulatory authorities.

This standard assumes an altitude of 2,000 m unless specified otherwise by the manufacturer.

This part of IEC 62368 does not apply to equipment to be used in wet areas. Additional requirements may apply.

Additional requirements for equipment intended for outdoor installation are given in IEC 60950-22.

This part of IEC 62368 does not address: - manufacturing processes except safety testing; - injurious effects of gases released by thermal decomposition or combustion; - disposal processes; - effects of transport (other than as specified in this standard); - effects of storage of materials, components, or the equipment itself; - the likelihood of injury from particulate radiation such as alpha particles and beta particles; - the likelihood of thermal injury due to radiated or

## 9. UL CERTIFICATIONS & SAFETY AGENCY COMPLIANCE CONTINUED

convected thermal energy; - the likelihood of injury due to flammable liquids; - the use of the equipment in oxygen-enriched or explosive atmospheres; - exposure to chemicals other than as specified in Clause 7; - electrostatic discharge events; - environmental aspects; - requirements for functional safety. NOTE 4 For specific functional and software safety requirements of electronic safety-related systems (for example, protective electronic circuits), see IEC 61508-1.

1DV.1 Modify Clause 1 by adding the following text after the third paragraph:

Battery backup systems that are not an integral part of stationary equipment, such as provided in separate cabinets, are subject to the appropriate standard for battery backup systems, such as UL 1973, Batteries for Use in Light Electric Rail (LER) Applications and Stationary Applications. NOTE See Figures 1.1 and 1.2 of UL 1973 for more information on independent electric energy storage systems (EESS) covered by UL 1973, which can consist of both low voltage (class ES or ES2) and high voltage (class ES3) subsystems, battery management, thermal management, and related features and safeguards. When interconnected with AV, IT, and CT Equipment, and typically used in conjunction with an uninterruptible power supply (UPS), such EESS typically serve as a short-term substitution of the mains supply during power outages and similar disturbances.

1DV.2 Modify Clause 1 by replacing the seventh paragraph with the following:

Additional requirements for information and communication technology equipment intended for outdoor installation are given in CSA/UL 60950-22. Additional requirements for audio/video equipment intended for outdoor installation are given in the relevant requirements in CAN/CSA C22.2 No. 60065 or UL 60065.

1DV.3 Modify Clause 1 by adding the following text:

1DV.3.1 This standard also is applicable to equipment designed to be installed in accordance with the Canadian Electrical Code, Part I, CSA C22.1-12; Canadian Electrical Code, (CEC) Part II, General Requirements, CAN/CSA C22.2 No. 0-10; the National Electrical Code, NFPA 70-2014; and the National Electrical Safety Code, IEEE C2-2012.

1DV.3.2 The standard is also applicable to equipment, when identified by a marking or instruction [see Annex dvk (Annex DVA, Clause 1 entry)], designed to be installed in accordance with Article 645 of the National Electrical Code, NFPA 70-2014 and the Standard for the Protection of Information Technology Equipment, NFPA 75-2013.

1DV.3.3 See Annex dva for requirements and references to regulatory requirements that apply to this equipment, as applicable.

1DV.4 Modify Clause 1 by adding the following text:

1DV.4.1 This standard includes additional requirements for equipment used for entertainment purposes intended for installation in general patient care areas of health care facilities. See Annex dvb.

## 9. UL CERTIFICATIONS & SAFETY AGENCY COMPLIANCE CONTINUED

1DV.4.2 This standard includes additional requirements for equipment intended for mounting under kitchen cabinets. See Annex dvc.

1DV.4.3 This standard does not apply to equipment having Remote Feeding Telecommunication (RFT) circuits. Equipment having RFT circuits is covered by CSA/UL 60950-21.

1DV.4.4 Additional requirements may apply to large data storage equipment. Refer to CSA/UL 60950-23.

1DV.4.5 This standard does not cover Modular Data Centers (MDCs), only the information and communication technology equipment contained within. NOTE: In the U.S., Modular Data Centers are covered by UL 2755, Modular Data Centers.

1DV.5 Modify Clause 1 by adding the following text:

### 1DV.5.1 Power Distribution Equipment and Sub-Assemblies

1DV.5.1.1 This standard also is applicable to power distribution subassemblies connected to a mains used to distribute power entirely within a system of equipment also covered by this standard, such as power distribution units (PDUs) in the form of cord-connected power strips and shelves with multiple power outlets (receptacles) and intended to be installed in system racks, cabinets, home entertainment centers, etc.

1DV.5.1.2 For equipment covered by this standard that incorporates components and sub-assemblies that perform a power distribution and control function covered by other standards, such as panelboards, load transfer equipment, or uninterruptible power systems utilized in power conditioners and computer power centers, this standard only may be used for investigation of safety for those aspects not covered by the other standards.

1DV.5.1.3 This standard also does not apply to stand-alone equipment used for distribution of mains power that is covered by individual power distribution equipment standards.

1DV.5.1.4 Based on the specific function, the following requirements are applicable to the stand-alone distribution equipment, or apply additionally to power distribution sub-assemblies and components of equipment covered by this standard, as described in 1dv.5.1.2 and 1dv.5.1.3:

- For Industrial Control Equipment, see CSA C22.2 No. 14 and UL 508.
- For Panelboards, see CSA C22.2 No. 29 and UL 67.
- For Switchboards, see CSA C22.2 No 244 and UL 891.
- For Transfer Switch Equipment, see CSA C22.2 No 178.1 and UL 1008.
- For Uninterruptible Power Systems, see CSA C22.2 No. 107.3 and UL 1778.



## 9. UL CERTIFICATIONS & SAFETY AGENCY COMPLIANCE CONTINUED

- For Power Distribution Centers for Communications Equipment, see UL 1801.
- For other forms of power distribution units for general applications, such as,
  - Relocatable Power Taps, see CSA C22.2 No. 21, Cord Sets and Power Supply Cords, and UL 1363, Relocatable Power Taps.
  - Cord connected Surge Protective Devices, see CSA Technical Information Letter No. A-24, Interim Certification Requirements for AC Line Connected Wiring Devices with Varistors, and UL 1449, Surge Protective Devices.
  - Furniture Power Distribution Units, see CSA C22.2 No. 21, Cord Sets and Power Supply Cords, and UL 962A, Furniture Power Distribution Units.

NOTE 1. It is assumed that power distribution equipment covered by the scope of this Standard is interconnected to the “Outlet” of a “Branch Circuit” as defined in Section 0 of the CEC, Part I, and Article 100 of the NEC. In the case of cord-connected equipment, the Outlet is the Receptacle associated with the building wiring. In the case of permanently connected equipment, the Outlet is the interface between the Branch Circuit conductors associated with the building wiring and the input terminals, pressure connectors, or leads associated with the power distribution equipment covered in whole or part by this standard. NOTE 2 The following are common definitions of the hardware with related functions that require additional investigation to the appropriate Canadian and U.S. standards. Industrial Control Panel - An assembly of two or more components consisting of one of the following:

- (1) Power circuit components only, such as motor controllers, overload relays, fused disconnect switches, and circuit breakers;
- (2) Control circuit components only, such as pushbuttons, pilot lights, selector switches, timers, switches, control relays; or
- (3) A combination of power and control circuit components.

These components, with associated wiring and terminals, are mounted on or contained within an enclosure or mounted on a subpanel. The industrial control panel does not include the controlled equipment. Panelboard - A single panel or group of panel units designed for assembly in the form of a single panel, including buses and automatic overcurrent devices, and equipped with or without switches for the control of light, heat, or power circuits; designed to be placed in a cabinet or cutout box placed in or against a wall, partition, or other support; and accessible only from the front. Switchboard - A large single panel, frame, or assembly of panels on which are mounted, on the face, back, or both, switches, overcurrent and other protective devices, buses, and usually instruments. Switchboards are generally accessible from the rear as well as from the front and are not intended to be installed in cabinets. Transfer Switch - An automatic or nonautomatic device for transferring one or more load conductor connections from one power source to another. Uninterruptible Power Supply - A power supply used to provide alternating current power to a load for some period of time in the event of a power failure.

## 9. TROUBLESHOOTING

If you have a problem, try isolating it first. For example, if there is no sound, try replacing the source with another audio source to see if you get sound. If it does work, then the problem is with the first source or the cables connecting them. If it doesn't work, then move forwards to identify if the problem exists within the amplifier, speakers, or the cables.

<b>Problem</b>	<b>Possible Cause</b>
<b>No Sound</b>	The volume may be turned down or muted. Check the volume settings on both the amplifier and the television/computer/CD player/etc.
<b>No Sound</b>	Make sure the proper source is selected on the amplifier or receiver.
<b>No Sound</b>	Check the cord connecting the amplifier with the source. The cord may be damaged or plugged into the wrong input or output.
<b>No Sound</b>	Check the wires connecting the amplifier with the speakers. Make sure they're connected properly and not damaged in any way.
<b>Poor Sound Quality</b>	If you hear something like static, or the sound is cutting in and out, check the audio cables. If the problem increases when a cable is being moved, then the cable is most likely faulty or not connected properly.
<b>Poor Sound Quality</b>	Today's audio systems may have several places to adjust the volume, for example your MP3 player may have a volume control, just as your amplifier has one. Check to be certain that the volume isn't turned up past 80% on any device.
<b>Poor Sound Quality</b>	Try changing sources to be certain that the selection you've chosen is a good quality recording.

## 10. TECHNICAL ASSISTANCE

If you have any questions or concerns about installing or using this product, you can reach us through the following method:

Phone: (844) 674-4461

Hours of operation: 8:00am - 5:00pm (Pacific Time), Mon - Fri

If you are having technical trouble, please have your model number ready and be prepared to explain briefly what steps you took to resolve the problem, to be best helped over the phone.

If you are considering returning the product, it's required that you contact Origin PRO prior to any return attempts. This way we can determine if the issue can be resolved without returning the product, or if needed we can provide instructions and support for the return process.

## 11. LIMITED 5-YEAR WARRANTY

Origin PRO warrants to the original retail purchaser only that this Origin PRO product will be free from defects in materials and workmanship, provided the speaker was purchased from an Origin PRO authorized dealer. If the product is determined to be defective, it will be repaired or replaced at Origin PRO's discretion. If the product must be replaced yet it is no longer manufactured, it will be replaced with a model of equal to or greater value that is the most similar to the original. If this is the case, installing the replacement model may require mounting modifications; Origin PRO will not be responsible for any such related costs.

### *Requirements & Warranty Coverage*

This warranty may not be valid if the product was purchased through an unauthorized dealer. This warranty only applies to the individual that made the original purchase, and it cannot be applied to other purchases. The purchaser must be prepared to provide proof of purchase (receipt). This warranty will not be valid if the identifying number or serial number has been removed, defaced, or altered.

### *Not Covered by Warranty*

- Accidental damage
- Damage caused by abuse or misuse
- Damage caused by attempted repairs/modifications by anyone other than ORIGIN PRO or an authorized dealer
- Damage caused by improper installation
- Normal wear, maintenance, and environmental issues
- Damage caused by voltage inputs in excess of the rated maximum of the unit
- Damage inflicted during the return shipment

All warranties and warranty conditions are subject to change. Please refer to [www.originpro.com](http://www.originpro.com) for the latest information.

## 12. RETURN PROCESS

Before making any return attempts, it is required that you first contact Origin PRO. Return product to Origin PRO or your dealer, either in person or by mail. It's preferable if the product is returned in the original packaging. If this is not possible, the customer is responsible for insuring the shipment for the full value of the product. This warranty is in lieu of all other expressed or implied warranties. Some states do not allow limitations on implied warranties, so this may not apply depending on the customer's location. (For more information, see Magnuson-Moss Warranty Act.)



11-28-23

6975 S Decatur Blvd, Las Vegas, NV 89118 • [www.originpro.com](http://www.originpro.com) • 844-674-4461

©2023 Origin PRO. All copyrighted, trademarked and patented elements mentioned herein are the sole property of Origin PRO.